

# larson®

Metal panels for architectural envelopes  
TECHNICAL INFORMATION NOTEBOOK

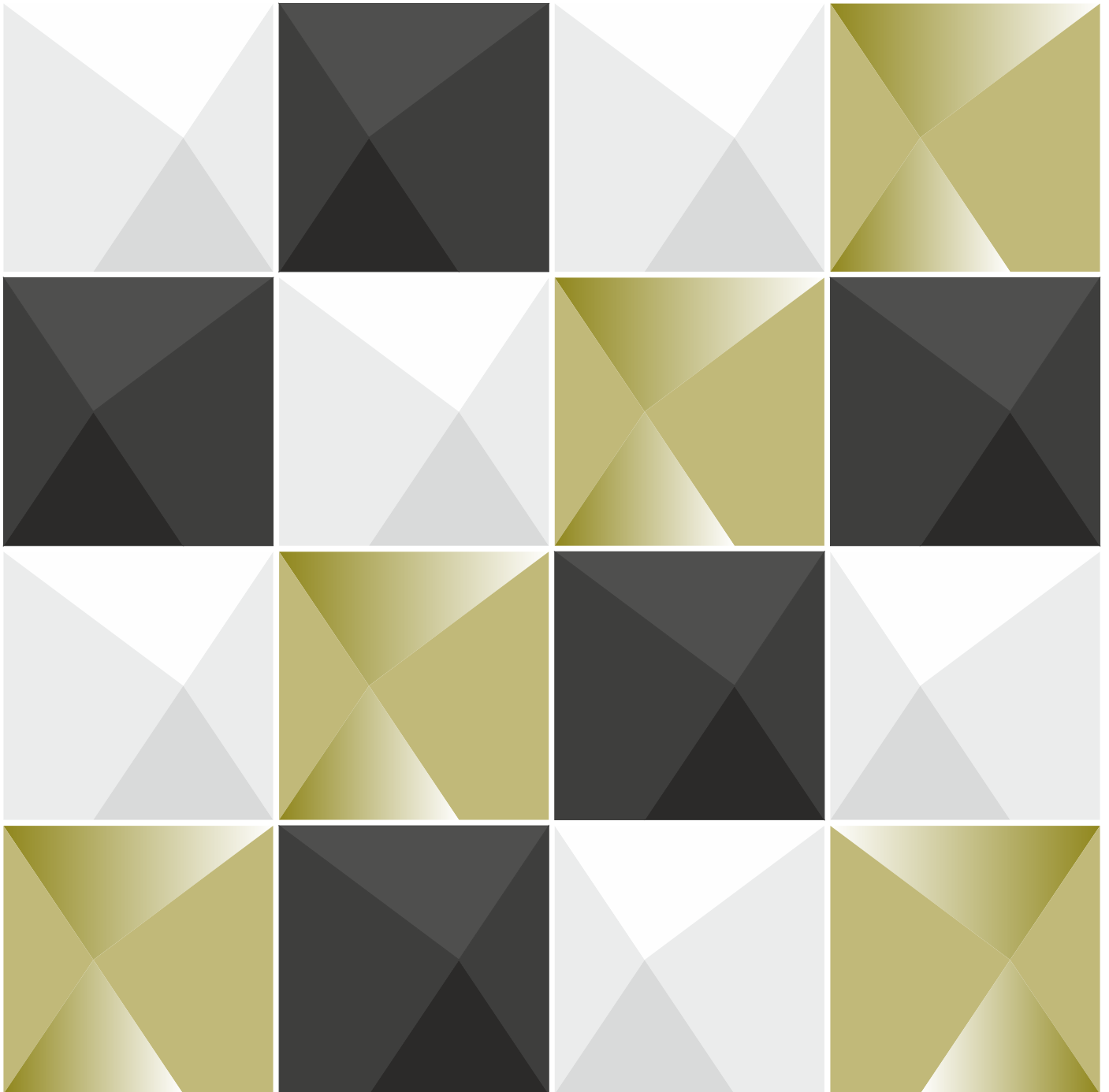

**Alucoil®**

Grupo Alibérico





## ÍNDICE

- 1. General considerations. Pag. 4.**
- 2. Products range. Pag. 5-7.**
- 3. Mechanical dimensional characteristics of the panel. Pag. 8-9.**
  - 3.1. Rigidity EI (kNcm<sup>2</sup>).
  - 3.2. Moment of inertial (mm<sup>4</sup>).
- 4. Mechanical dimensional characteristics of the aluminium. Pag. 8-9.**
  - 4.1. Modulus of elasticity E (N/mm<sup>2</sup>).
  - 4.2. Elasticity limit R<sub>p0.2</sub> (N/mm<sup>2</sup>).
  - 4.3. Ultimate tensile strength R<sub>m</sub> (N/mm<sup>2</sup>).
  - 4.4. Elongation A (%).
- 5. Different types of coating. Pag. 10.**
- 6. Comparative table about types of coating. Pag. 11.**
- 7. Certifications and full scale test. Pag. 12-15.**
- 8. Transport and storage. Pag. 16.**
- 9. Identification and recommendations about how install larson<sup>®</sup>. Pag. 16-17.**
- 10. Lineal thermal expansion of larson<sup>®</sup>. Pag. 18.**
- 11. larson<sup>®</sup> machining. Pag. 19-23.**
  - 11.1. Cutting.
  - 11.2. Routing.
  - 11.3. Bending.
  - 11.4. Curving.
  - 11.5. larson<sup>®</sup> perforated.
- 12. Wind loads and pressure. Pag. 24-25.**
- 13. larson<sup>®</sup> behavior under wind loads. Pag. 26-27.**
- 14. larson<sup>®</sup> cassette. Pag. 28-32.**
  - 14.1. Standard cassette.
  - 14.3. Cassette shaped.
  - 14.4. Cassette development.
  - 14.5. Vertical stiffeners (PCI).
  - 14.6. Horizontal stiffener (LC-RH).
  - 14.7. Screws/rivets.
- 15. Inspection and maintenance guidelines. Pag. 33-35.**
- 16. Organization of the work. Pag. 36.**
- 17. Installation systems. Pag. 37.**
  - LCH-1 (cassettes). Pag. 38-51.
  - LC-4 / LC-6 system (cassettes). Pag. 52-67.
  - Riveted system (panels). Pag. 68-79.
- APPENDIX I. Consideraciones específicas para larson<sup>®</sup>. Pag. 80.**
- APPENDIX II. Información sobre acabados especiales. Pag. 81-83.**



## 1. General considerations.

- **larson**<sup>®</sup> panels must be installed on buildings following always the regulations, technical guidelines and building codes regarding classification and protection against fire of each country where they are to be installed. **Alucoil**<sup>®</sup> has a wide range of products to meet the requirements of each country.
- It is the responsibility of the customer to prove that they are complying with the end use of the product and with the building regulations or building technical approvals applicable to the place of installation.
- Pallets are to be kept dry during transportation.
- Products must be stored in a dry and cool place and protected from sun, rain and snow.
- The maximum storage period is 8 months. It is recommended that the original pallets are stacked one on top of the other up to a maximum of 6. Wooden blocks should always be matched when stacking.
- For the correct transformation of **larson**<sup>®</sup> panels, follow the recommendations described in this document, available on **www.alucoil.com**
- All processing of **larson**<sup>®</sup> **FR** composite sheets must be done at a metal temperature of over 10°C and of **larson**<sup>®</sup> **A2** over 17°C, with the protective plastic film on to prevent damages to the coated surface. The protective plastic film must not be removed until all works on the site have been completed. Do not remove the protective foil using cutters or sharp tools.
- Attend the particularities of each finish, especially Alunatural, Embossed and Real Anodized range. If they have not been provided to you by **Alucoil**<sup>®</sup>, please request them.
- Milling/routing must be done on the back side of the **larson**<sup>®</sup> panel, i.e., the opposite side of the protective plastic film.
- Install panels or trays ALWAYS in the same direction following the arrows on the protective plastic foil.
- To ensure colour consistency, the total quantity requirement for one project should be ordered at one time.
- Remove the protective foil as soon as possible after installation but at temperatures above 10°C.
- To ensure proper performance of the **larson**<sup>®</sup> panels, follow the recommendations described in this document, available on **www.alucoil.com**

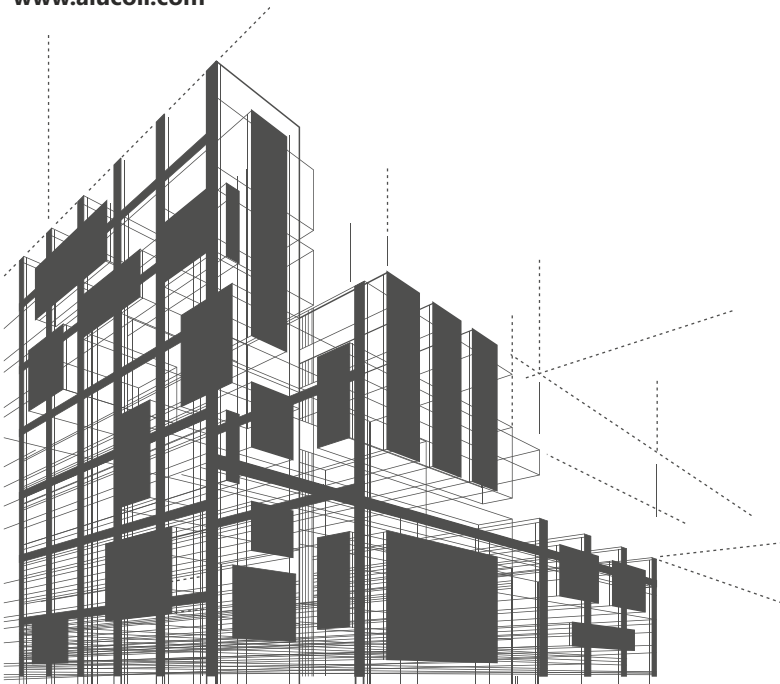



## 2. Products range.

**larson®** composite panel, is a high-tech product for architectural façade cladding. It is formed with two aluminium sheets, 5005 alloy, bonded by a mineral core.

According to the core used the product can be:

- **larson® FR**

It is bonded by a mineral fire retardant (FR) core that delays panel combustion which allows this material to achieve B-s1,d0 classification, according to the EN 13501-1 standard.

- **larson® A2**

This panel has been developed to be used in those countries whose regulations prevent the use of other types of composite panels which don't achieve the A2-s1, d0 fire class.

# larson®

## Aluminium composite panels

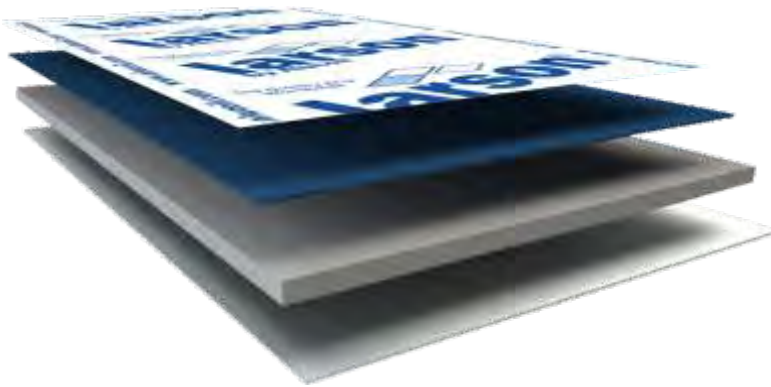

## larson® FR panel with EPD® Environmental product declaration

We manufactured too **larson® METALS** range, composite panels with the same properties where their sheets are made of stainless steel, copper, brass or zinc. A magnificent commitment to noble materials and natural aging.

### Dimensional characteristics of larson®

- Metal thickness "e<sub>1</sub>/e<sub>2</sub>" (mm). The thickness of the outer sheet metal (e<sub>1</sub>) and the thickness of the inner sheet metal (e<sub>2</sub>)
- Panel thickness. The thickness of the composite panel is measured in millimeters (mm) and it is the sum of the thickness of the outer metal sheet (e<sub>1</sub>) + core thickness (FR or A2) + the thickness of the inner sheet metal (e<sub>2</sub>).
- Panel weight (Kg/m<sup>2</sup>). The weight changes depending on the panel thickness, type of metal and metal thickness, and the type of core.
- Minimum and maximum length "L" (mm). **Alucoil®** can fabricate a minimum length of 2000mm due to the characteristics of its production line. Shorter lengths may be obtained after cutting panels. The maximum length produced is 8000mm because of CNC machine dimensions of **Alucoil®**.
- Standard width "H" (mm). Aluminium standard widths are 1000 / 1250 / 1500 mm. It is also possible to produce on request any width between 900 mm and 2000 mm.



# larson® FR

Aluminium composite panel with FR mineral core retarding the combustion



1. Protective film 100µ
2. 0,5 mm coated aluminium
3. FR mineral core
4. 0,5 mm aluminium + primer



3 mm  
4 mm  
6 mm

## Dimensional features of **larson® FR**

<b>External aluminium thickness</b>	0,5 mm alloy 5005 <sup>(*)</sup> EN 573-3
<b>Internal aluminium thickness</b>	0,5 mm alloy 5005 <sup>(*)</sup> EN 573-3
<b>Panel thickness</b>	3 mm    4 mm    6 mm
<b>Panel weight</b>	6,14 kg/m <sup>2</sup> 7,78 kg/m <sup>2</sup> 11,06 kg/m <sup>2</sup>
<b>Standard width</b>	1000 / 1250 / 1500 mm
<b>Min. / max. length</b>	From 2000 to 8000 mm

<sup>(\*)</sup>Other alloy availables. Alunatural finishes - alloy 3000

## SALT SPRAY TEST - PEELING TEST - CORE CALORIC VALUE

# larson® FR

### Tests - **larson® FR**

<b>Salt - spray test (CNS) 4000 hours</b> Test according to EN ISO 9227, tested in the laboratory of <b>Alucoil®</b> .	NON DESLAMINATION
<b>Initial adherence (PEELING TEST) N/25 mm</b>	600-700
<b>Lost of adherence after 4000 hours in CNS (PEELING TEST)</b> Test according to EN ISO 9227, tested in the laboratory of <b>Alucoil®</b> .	0% - 10%
<b>Core high caloric value (MJ/kg) EN ISO 1716</b> Tested in a external laboratory.	12,91



# larson® A2

Aluminium composite panel with A2 mineral core non combustible



1. Protective film 100µ
2. 0,5 mm coated aluminium
3. A2 mineral core
4. 0,5 mm aluminium + primer



4 mm

## Dimensional features of **larson**® A2

<b>External aluminium thickness</b>	0,5 mm alloy 5005 <sup>(*)</sup> EN 573-3
<b>Internal aluminium thickness</b>	0,5 mm alloy 5005 <sup>(*)</sup> EN 573-3
<b>Panel thickness</b>	4 mm
<b>Panel weight</b>	8,25 kg/m <sup>2</sup>
<b>Standard width</b>	1250 / 1500 mm
<b>Min. / max. length</b>	From 2000 to 8000 mm

<sup>(\*)</sup>Other alloy availables. Alunatural finishes - alloy 3000.

## SALT SPRAY TEST - PEELING TEST - CORE CALORIC VALUE

# larson® A2

### Tests - **larson**® A2

<b>Salt - spray test (CNS) 4000 hours</b> Test according to EN ISO 9227, tested in the laboratory of <b>Alucoil</b> ®.	NON DESLAMINATION
<b>Initial adherence (PEELING TEST) N/25 mm</b>	500-600
<b>Lost of adherence after 4000 hours in CNS (PEELING TEST)</b> Test according to EN ISO 9227, tested in the laboratory of <b>Alucoil</b> ®.	Product not recommended for coastal areas or humid environments and/or extreme temperatures
<b>Core high caloric value (MJ/kg) EN ISO 1716</b> Tested in a external laboratory.	1,74



### 3. Mechanical properties of larson®.

3.1. Rigidity "EI" (KNcm<sup>2</sup>): rigidity is calculated multiplying the moment of inertia by elastic modulus, under given load and support configurations. The higher the rigidity, the lower deflection obtained.

3.2. Moment of inertia "I" (mm<sup>4</sup>): section property that quantifies its amount of mass (area) in relation to its gravity center. Stress and deflection obtained under a certain load applied to a panel are directly influenced by its moment of inertia (the greater the inertia, the less stress and deflection under the same load).

#### BENDING TEST ACCORDING TO DIN 53 293

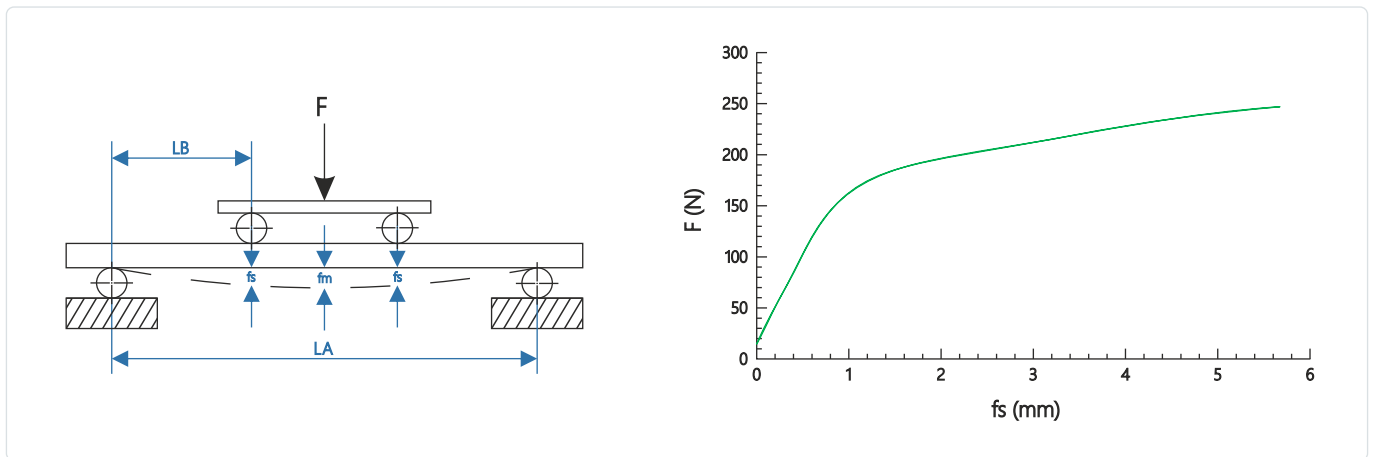

### 4. Mechanical properties of aluminium.

4.1. Modulus of elasticity "E" (N/mm<sup>2</sup>): also known as Young Modulus, it is a typical constant of elastic materials that relates the force applied to the deflection or displacement obtained. The higher the modulus of elasticity the lower deflection for a given load.

4.2. Elasticity limit " $R_{p0.2}$ " (N/mm<sup>2</sup>): maximum stress an elastic material can stand so it can recover from obtained deflection up to 99.8% once the applied force is removed. The higher the limit, the more difficult to cause permanent deformation of the panel.

4.3. Ultimate tensile strength " $R_m$ " (N/mm<sup>2</sup>): material breakage stress. Once the yield strength is exceeded, the material continues deforming without breaking, but undergoes plastic deformation (non-recoverable deformation). The material breaks when it reaches its ultimate tensile strength.

4.4. Elongation "A" (%): length increase of an element (expressed in percentage) since it exceeds the elasticity limit until the breakage appears.

#### Main properties of the aluminium:

- Low density.
- Good formability.
- Resistance to corrosion.
- Heat conduction.
- Impact resistance.
- Electricity conduction.
- High resistance.
- Recyclability.
- Surface treatments such as painting or anodizing.







## larson® FR

### Panel features

	larson® FR 3 mm	larson® FR 4 mm	larson® FR 6 mm
<b>Rigidity (EI)</b>	1108 kNcm <sup>2</sup> /m	2150 kNcm <sup>2</sup> /m	6041 kNcm <sup>2</sup> /m
<b>Moment of inertia (I)</b>	1583 mm <sup>4</sup> /m	3070 mm <sup>4</sup> /m	8630 mm <sup>4</sup> /m
<b>Core</b>	MINERAL FIRE RETARDANT		
<b>Fire class</b>	<p><b>B-s1, d0 EN 13501-1</b>                      Alucoil®'s vertical riveted &amp; 45mm cassette installation systems.  <b>BS 8414-1 Ensayo a gran escala</b>                      Details of tested constructive system appear in Tecnia's 070717-002A report.  <b>NFPA 285 Ensayo a gran escala</b>                      Details of tested constructive system appear in Intertek's 102936114SAT-004B report.</p>		

### Coated aluminium features

<b>Standard aluminium alloy</b>	5005 <sup>(*)</sup> EN 573-3
<b>Modulus of elasticity (E)</b>	70000 N/mm <sup>2</sup>
<b>Ultimate tensile strength (R<sub>m</sub>)</b>	125 < R <sub>m</sub> < 185 N/mm <sup>2</sup>
<b>Elasticity limit (R<sub>p0,2</sub>)</b>	> 80 N/mm <sup>2</sup>
<b>Elongation (A)</b>	> 3 %
<b>Aluminium thermal expansion</b>	2,3 mm/m Δ100°C

<sup>(\*)</sup>Other alloy available. Alunatural finishes - 3000 series alloy.  
 Some data can be estimated or extrapolated. Consult with the Alucoil® technical department to confirm exact values to be used in specific calculations or projects.

## larson® A2

### Panel features

	larson® A2 4 mm
<b>Rigidity (EI)</b>	2150 kNcm <sup>2</sup> /m
<b>Moment of inertia (I)</b>	3070 mm <sup>4</sup> /m
<b>Core</b>	MINERAL A2
<b>Fire class</b>	<p><b>A2-s1, d0 EN 13501-1</b>                      Vertical riveted system &amp; 45mm cassette system of Alucoil®.  <b>BS 8414-2 Ensayo a gran escala</b>                      Cassette system of Alucoil®.</p>

### Coated aluminium features

<b>Standard aluminium alloy</b>	5005 <sup>(*)</sup> EN 573-3
<b>Modulus of elasticity (E)</b>	70000 N/mm <sup>2</sup>
<b>Elasticity limit (R<sub>p0,2</sub>)</b>	125 < R <sub>m</sub> < 185 N/mm <sup>2</sup>
<b>Ultimate tensile strength (R<sub>m</sub>)</b>	> 80 N/mm <sup>2</sup>
<b>Elongation (A)</b>	> 3 %
<b>Aluminium thermal expansion</b>	2,3 mm/m Δ100°C

<sup>(\*)</sup>Other alloy available. Alunatural finishes - 3000 series alloy.  
 Some data can be estimated or extrapolated. Consult with the Alucoil® technical department to confirm exact values to be used in specific calculations or projects.



## 5. Different types of coating.

**PVDF (Polyvinylidene Fluoride).** Coating based on PVDF resins (Kynar and Hylar as main brands) with extraordinary performance.

Nominal paint thickness:

a) **PVDF 2L Coastal:** 31 µ approx.

- *Gloss levels from 20 to 40 g.u.*
- *Excellent colour stability, almost no chalking and very good chemical resistance.*
- *Great protection against weathering, UV radiation and atmospheric contaminants.*
- *Outstanding flexibility for profiling, bending and roll forming.*
- *Recommended for demanding environments like industrial and coastal areas, airports, etc.*

**DG5 (High Durable Polyester).** Coating based on HDP resins.

Nominal paint thickness:

a) **DG5 2L Coastal:** 35 µ approx, (depending on the colour)

b) **DG5 3L Coastal:** 55 µ approx, (depending on the colour)

c) **DG5:** 25 µ approx.

- *Gloss levels from 10 to 90 g.u.*
- *Outstanding protection against weathering, UV radiation and atmospheric contaminants.*
- *Excellent hardness and flexibility for profiling, bending and roll forming.*

**PUR/PA (Polyurethane/Polymaïnde).** Coating based on polyurethane resins.

- *Very flexible and good formability.*
- *Good chemical resistance.*
- *Outstanding scratch resistance and high abrasion resistance.*
- *Good substrate adhesion: also used in primer systems.*

## **NEW fluorlac®** Coating for **larson®** panels

FEVE LUMIFLON 2 LAYERS. Lumiflon fluoropolymer resins based coating with a nominal thickness of 25µ, (depending on the colour).

### COLOURS:

- *RAL & NCS colour charts with matt, satin and high gloss finishes.*
- *Matched colours.*

### QUANTITIES:

- **Orders from 75 sqm.**

### SERVICES:

- *Very short delivery times, **2-3 weeks.***
- *One face coated with a protective film of 100µ thick.*

### Other characteristics:

- *Excellent weatherability and chemical resistance.*
- *High abrasion resistance.*

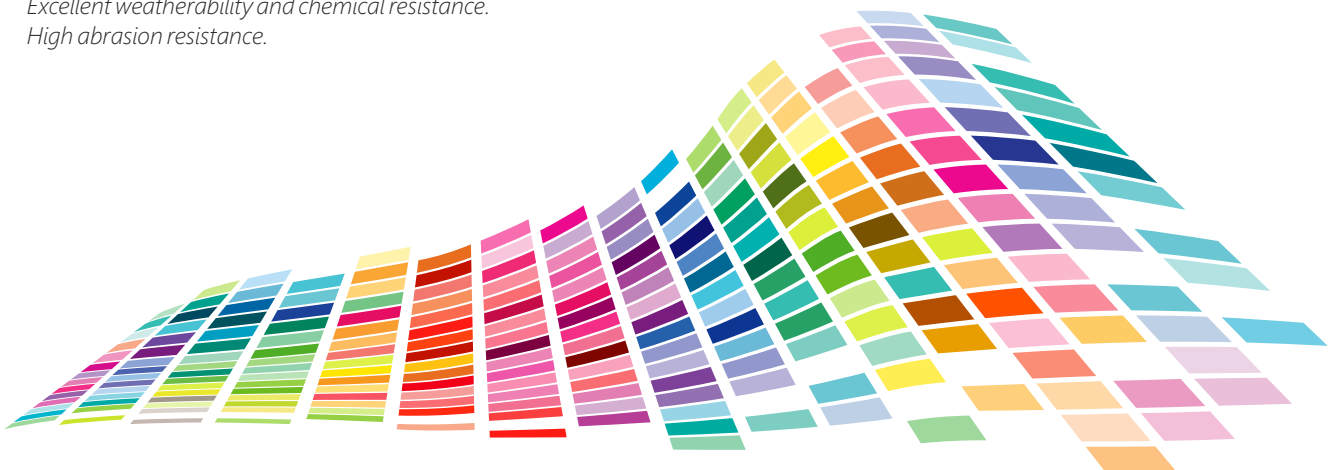



6. Comparative table about types of coating.

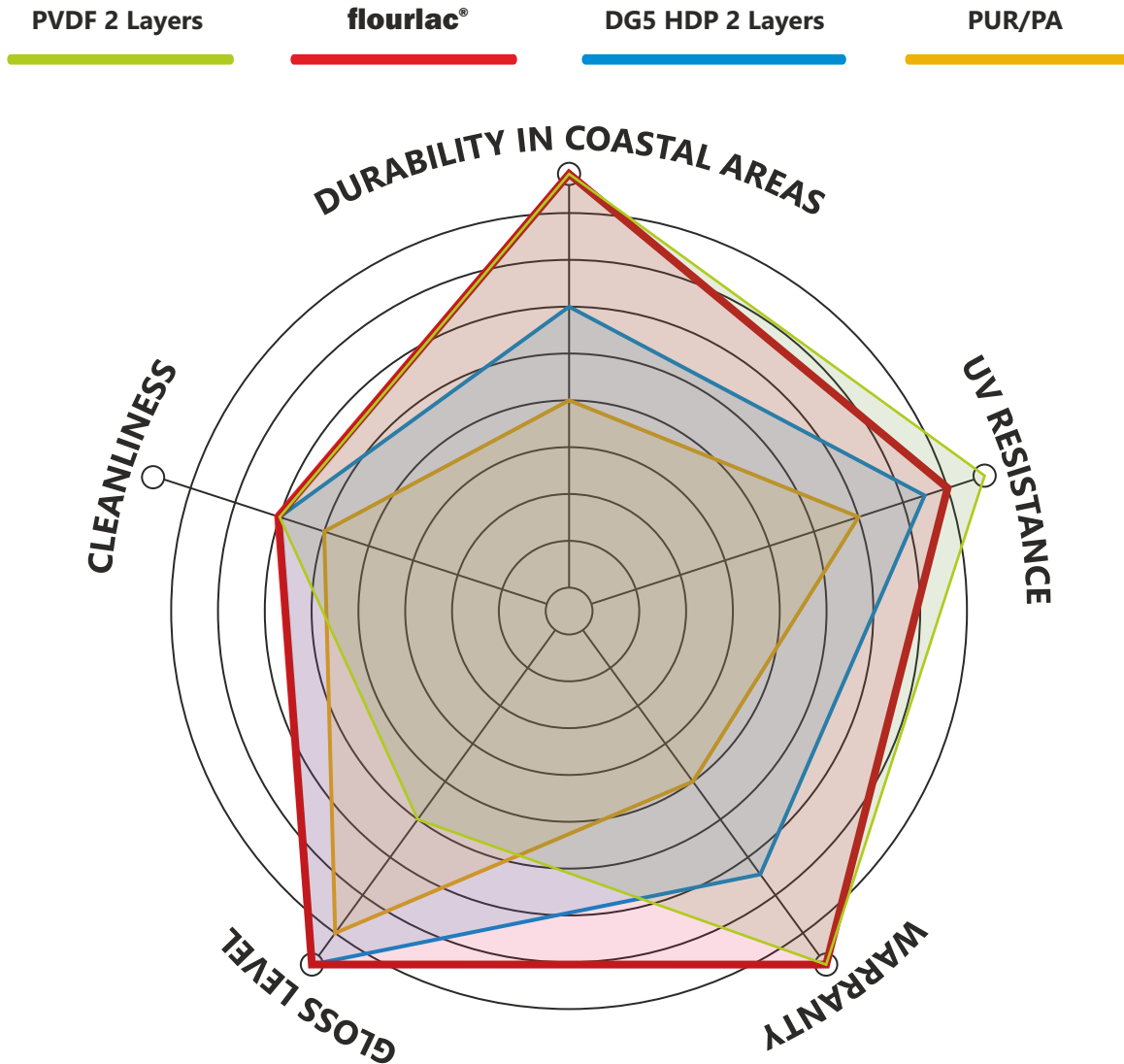

**PVDF**

PVDF 2L COASTAL: 31µ  
 Polyvinylidene Fluoride

Maximum quality in liquid paint.  
 Wide range of solid and metallic colours.  
 Gloss level limitations (20G - 40G).

**flouirlac®**

FEVE 2L: 25µ  
 Fluoropolymer

Available in small quantities in any RAL colour.  
 High quality liquid paint.  
 Low dirt adhesion.  
 Gloss levels from 10G to 90G.

**DG5 (HDP)**

DG5 2L Coastal: 35µ  
 High Durable Polyester

Maximum versatility of finishes:  
 HOLO, DESIGN & TEXTURED (wood-concrete-corten steel)  
 Super matt 2G - 10G  
 High gloss level 90G

**PUR/PA**

ALUNATURAL 16µ  
 Polyurethane / Polymaïnder

Transparent special coating for Alunatural finishes.



## 7. Certificates - Full scale test & classifications.

### 7.1 ENVIRONMENTAL CERTIFICATE

#### International →

Environmental label.  
EPD® Environmental product declaration.  
- **larson® FR.**

First Building products with dual-registered EPDs



### 7.2 PRODUCT CERTIFICATES WITH INSTALLATION SYSTEM

#### European union →

ETA EUROPEAN TECHNICAL ASSESSMENT → CE mark.  
- **larson® FR** with LCH-1 system "ETA 14/100".

#### Spain →

DIT PLUS Technical Approval Document.  
- **larson® FR** with LCH-1 system "DIT PLUS 405P/15".

#### Germany →

Certificate U MARK.  
- **larson® FR** with riveted system "Z-10.3-808".

#### France →

SELLO QB 64-79 (**larson® FR**).  
SELLO QB 142-153 (**larson® A2**).  
- **larson® FR & larson® A2** with LCH-1 system "AVIS TECHNIQUE 2.2-14-1643-V3".  
- **larson® FR & larson® A2** with riveted system "AVIS TECHNIQUE 2.2-11-1469-V3".



ETA 14/0010  
**Alucoil®** Suspended Cassette  
ETA 14/0010  
**Alucoil®** Riveted Boards



TECHNICAL APPROVAL DOCUMENT  
N° 405P/15  
**larson®** Suspended Cassettes  
**larson®** Riveted Boards



QB 15-Built-up cladding products  
N° 64-79 & N°142-153

Manufactured by: **Alucoil® S.A.U.** - Product: **larson®**



2.2/14-1643\_V3 issued 16/12/2020  
2.2/11-1469\_V3 issued 24/09/2020



## 7.3 PRODUCT CERTIFICATES

### European Union →

ETA EUROPEAN TECHNICAL ASSESSMENT → CE mark.

- **larson® A2** "ETA 18/0712".

### United Kingdom →

BBA.

- **larson® FR** "BBA 08/4551".

### USA & Canada →

ETL.

- **larson® FR** "SDReport 29779".

### Switzerland →

VKF.

- **larson® FR** "VKF 30224".

- **larson® A2** "VKF 30219".

### Ukraine →

UA.BR.

- **larson® FR** "UA.BR.042,012-20".



ETA 18/0712  
**larson® A2** composite panel



**Intertek**  
C#5007929





## 7.4 FULL SCALE FIRE TEST & CLASSIFICATIONS

### European Union →

Fire classification of construction products and building elements.

- **larson® FR** with riveted & cassette systems B-s1, d0 according to EN 13501-1.
- **larson® A2** with riveted & cassette systems A2-s1, d0 according to EN 13501-1.

### United Kingdom →

Full-scale Fire performance of external cladding systems.

- **larson® FR** with riveted system, according to BS 8414-1, BR 135 passed.
- **larson® A2** with cassettes system, according to BS 8414-2, BR 135 passed.

### France →

Full-scale fire test LEPİR II.

- **larson® FR & larson® A2** with riveted & cassettes suspended systems, according to LEPİR II.

Reaction to fire tests. Heat release, smoke production and mass loss rate. Part 1: Heat release rate (cone calorimeter method) and smoke production rate (dynamic measurement). Amendment 1.

- **larson® FR**. PASSED according to ISO 5660-1.

### Czech Republic →

Fire behaviour.

- **larson® FR**, according to CSN 73 0863.

### Australia & NZ →

Methods for fire tests on building materials, components and structures.

Simultaneous determination of ignitability, flame propagation, heat release and smoke release and products using an oxygen consumption calorimeter.

- **larson® FR**, according to AS NZS 1530.3 1999.

Identification **larson® FR** core by ash content and XRD.

- **larson® FR**, according to ASTM D5360-13.

Corner room test.

- **larson® FR**, "Group 1" & "Group 2" according to ISO 9705.





**USA & Canada →**

Full scale fire test. Standard fire test method for evaluation of fire propagation characteristics of exterior wall assemblies containing combustible components.

- **larson® FR** with EVO system, according to NFPA 285.

Standard test method for surface burning characteristics of building materials.

- **larson® FR**, according to ASTM E84-12c.

Full scale standard method of fire test of exterior wall assemblies.

- **larson® FR** 6 mm, according to CAN ULC S134 92.

Product evaluation **larson® FR** new system against fire compliance [OK].

- **larson® FR** 4 & 6 mm, according to CAN ULC S134.

Standard method of test for surface burning characteristics of building materials and assembly.

- **larson® FR** 6 mm, according to CAN ULC S102-10.





## 8. Storage and transportation.

Always be careful not to damage the pallets where **larson®** panels are stored. For this, a certain emphasis must be placed on their transport and storage.

- **larson®** panels will be stored in pallets with the appropriate size to the width and length of the sheets.
- All panels are protected with a film to avoid scratches or physical damage during handling.
- The pallets are properly closed, strapped and sealed with a protective film.
- The pallets must be moved with the appropriate forklifts to handle the length of the sheets.
- Never put more than 6 pallets in height and never exceed 10000 kg.
- Pallets should never be stored for over 8 months.

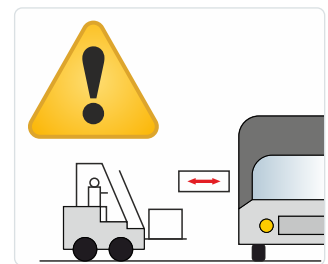
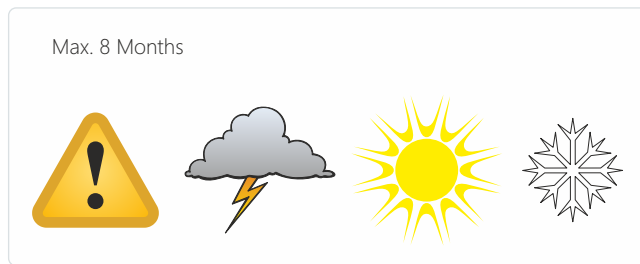
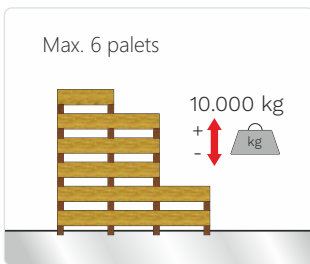

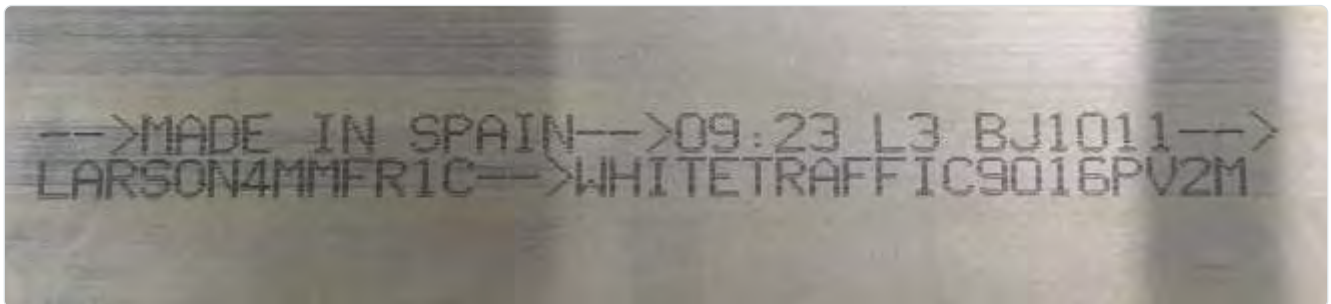

## 9. Recommendations for the installation of the composite panel

- **larson®** panels are marked on the back face during manufacturing process with an alphanumeric code. This is for the tracking of panels in case of any issue.
- Manufacturing batches are correctly labeled with their tracking.
- All panels for the same project should be ordered in one order as there are possible colour differences between different batches.



Digital printing inside the panel

				Dirección Entrega Pol. Ind. Bayas C/ Irco Parc. R72/77 Miranda de Ebro España		 SSCC (00) 0000000000000000 FR-PG-05C-07; Ed. 1 (15/01/09)		
Descripción	Color	Medidas	Pedido de venta	Unidades	Cantidad			
LA0005 - LARSON 4mm FR 1C	TRAFFIC WHITE 9016 PVDF2	1500x5250	PV0000000	20	158 m <sup>2</sup>			
<b>Cli.: Alucoil, S.A.U.</b>		<b>PV: PC-0000/19</b>						
Peso neto aproximado ...: 1256 kg			Peso bruto aproximado ...: 1575 kg					

Manufacturing label





- All **larson**® panels are protected by a protective film which has printed recommendations for removal. This protective film has a series of arrows in its design.
- The panels manufactured by **Alucoil**® must be installed with the arrows of the film in the same direction.



larson® protective film

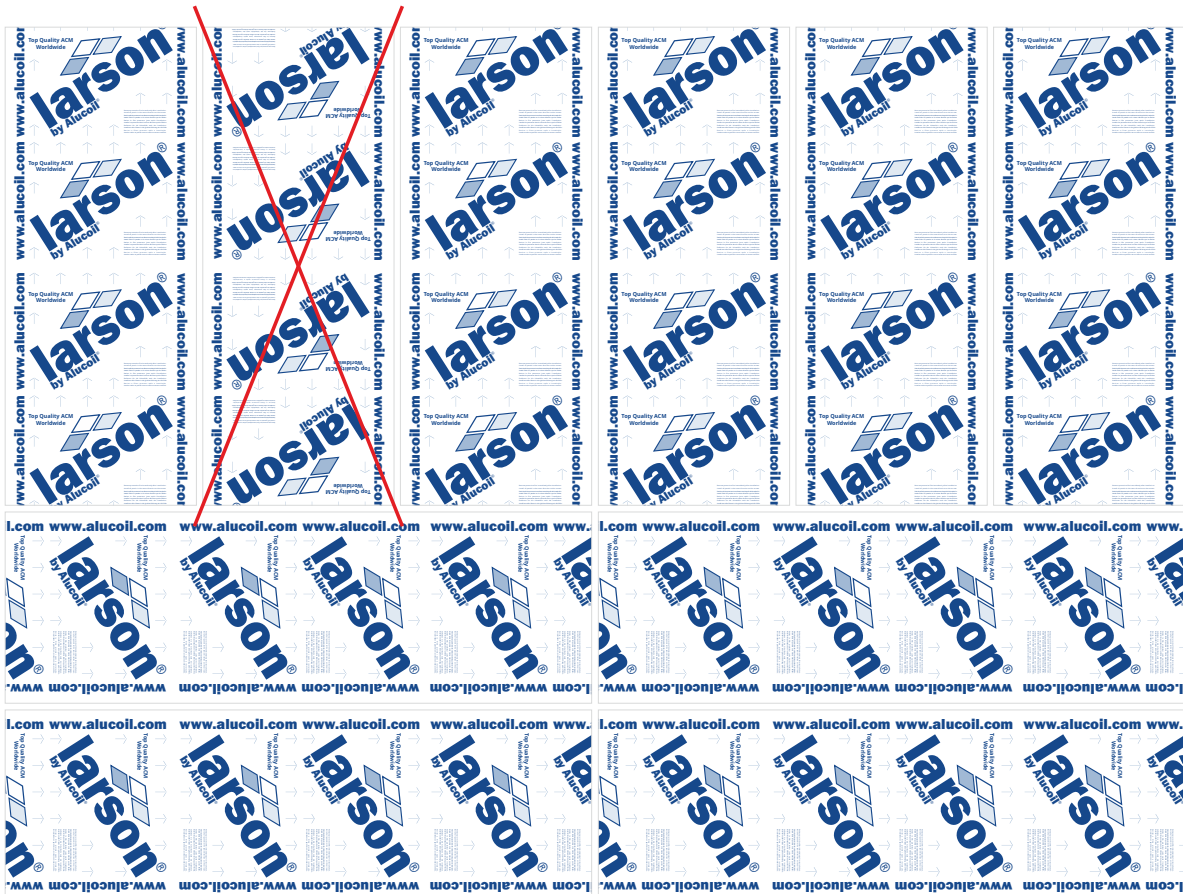

Incorrect position of a panel with metallic finishes and / or indicated colors



## 10. Lineal thermal expansion of larson®.

Due to thermal influences, the magnitude of contraction or expansion has to be calculated to the size that the joint expansion areas require.

This is defined by:  $\Delta L = \alpha \times \Delta T \times L$

Where " $\alpha$ " is the coefficient of expansion of the composite panel and the aluminium:  $2,4 \times 10^{-5} \text{C}^{-1}$ , being " $\Delta T$ " temperature variation and " $L$ " length or height of the cassette/panel.

### Very important:

- According to the lineal thermal expansion of the panel we must calculate the minimum dimension of the joints between panels.
- Consider expansions in horizontal and vertical.
- The maximum possible temperature variation are 100°C.
- Use the necessary tools to put the rivets in the holes correctly on the panel.
- Moving or fixed points in the holes during machining of the panel.
- Use of retention and support brackets for dilation control in the vertical profiles.
- The expansion joints of the profile must match the expansion joints of the panel.

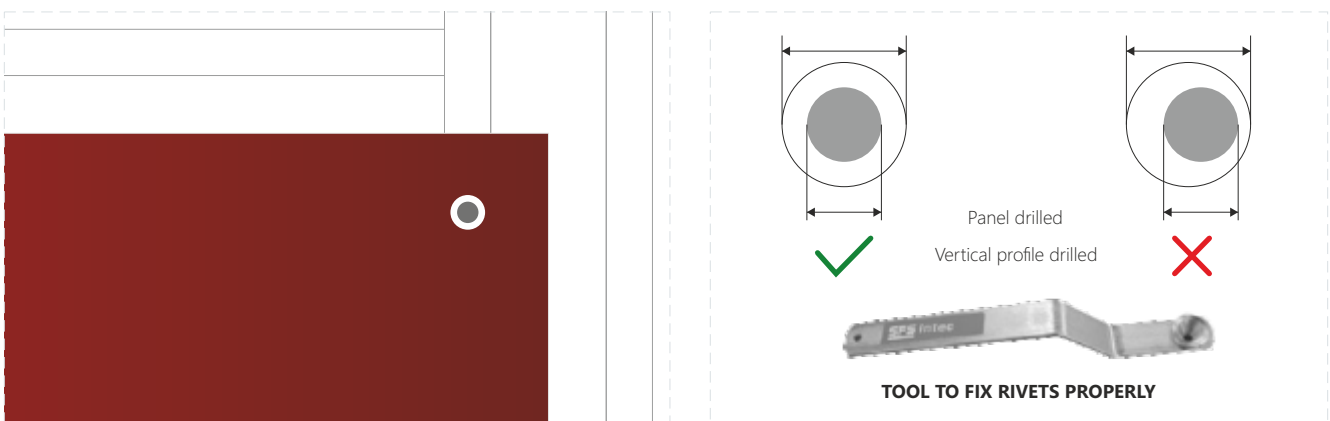
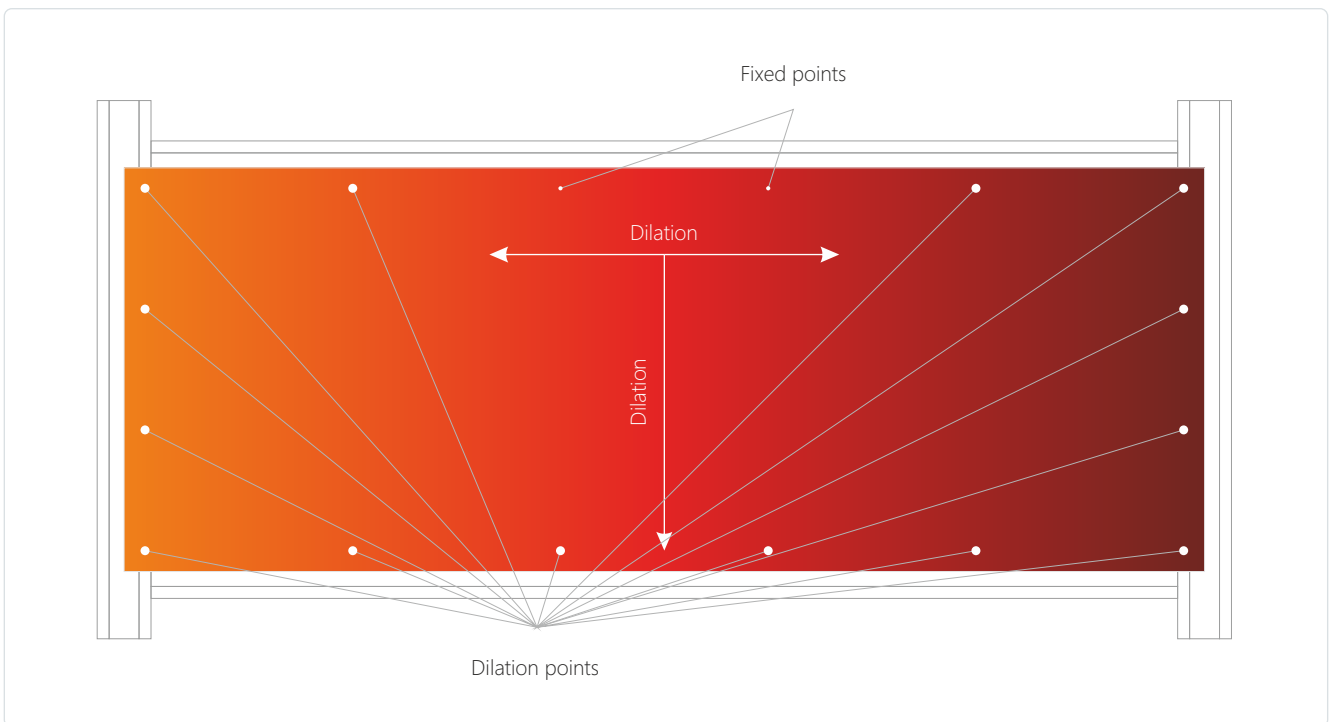

Thermal expansion of the composite panel



## 11. Machining of composite panel.

- 11.1. Cutting.
- 11.2. Routing.
- 11.3. Bending.
- 11.4. Curving.
- 11.5. Perforated.

The advanced manufacturing process of **larson®** composite panels brings out an extremely tight adhesion between the different layers and coats. Every tests carried out on our products have at least doubled the recommended parameters according to several standards. Thanks to the perfect bond between the different layers of **larson®** composite panels, they have an immense capacity to allow multiple types of machining and manipulation . All works detailed below shall be carried out at temperatures over 10°C:

### 11.1. Cutting.

Cutting can be performed in:

- Manual saw machines.
- Vertical saws (straight cuts).
- CNC machines (straight and curved cuts).
- Guillotine (straight cuts): **larson® Metals Stainless Steel**.

### 11.2. Routing.

Routing can be performed in:

- Portable routing machines.
- Vertical manual routing with feeler.
- CNC machines.



#### MANUAL ROUTING MACHINES



#### ROUTING IN VERTICAL SAW WITH FOR:

**larson® A2/FR - larson® A2/FR Metals**

Diameter disc 244 x 14 mm  
 Material: High speed steel (HSS)  
 Standard speed  $V_c$ : 5000 rpm  
 Standard advanced  $f_r$ : 16 m/min



#### ROUTING IN CNC WITH DISC FOR:

**larson® A2/FR - larson® A2/FR Metals**

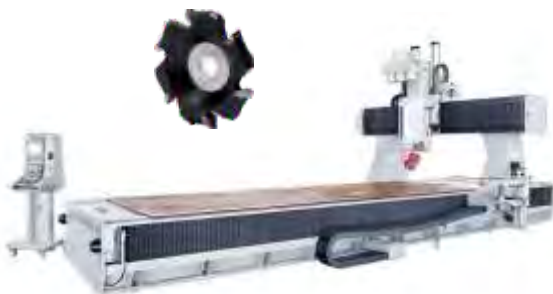

#### ROUTING IN CNC WITH TOOL FOR:

**larson® A2/FR - larson® A2/FR Metals (except stainless steel)**

CERIN tool "V" Ø 12 mm -  $\alpha = 45^\circ$

Hard Metal / 3 Cutting lips

- Standard speed  $V_c$ : 12000 rpm
- Standard advanced  $f_r$ : 25m/min



**larson® A2/FR Metals Stainless steel:**

CERIN tool "V" Ø 12 mm -  $\alpha = 45^\circ$

Hard Metal + TIALM / 3 Cutting lips

- Standard speed  $V_c$ : 2200rpm
- Standard advanced  $f_r$ : 8m/min



### 11.3. Bending.

Making folding on its surface (from now on edges) of the panel we can get infinite shapes or geometries.

**larson**<sup>®</sup> composite panel is a material very easy to mechanizing. Only with routing and folding the edges we can transform the panel into cassettes with the most varied shapes.

The folding must be made by a special tool. Panel area in contact with the tool and also the area leaning on the mold should be protected to prevent damages.

When we make the milling and folding, the following considerations must be taken into account:

#### T-bend > 2

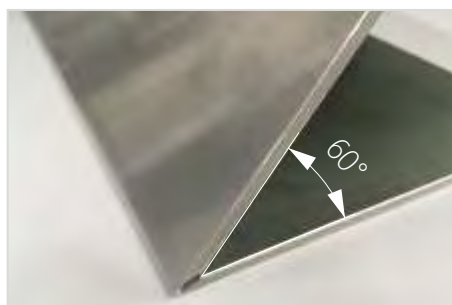
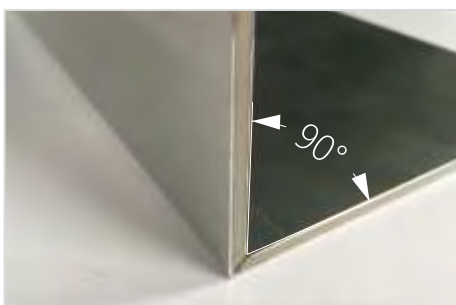
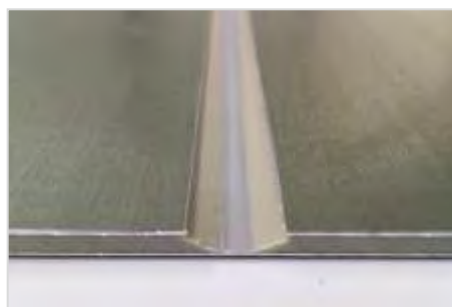
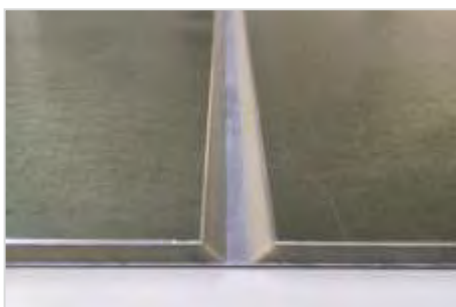
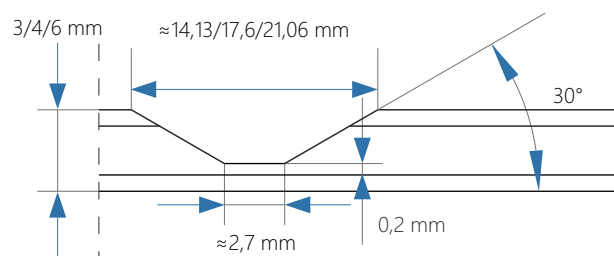
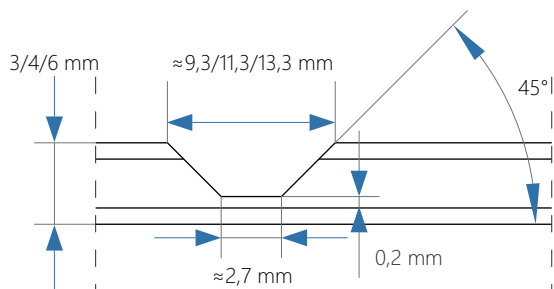



**REAL DIMENSION AND DISTANCE BETWEEN ROUTING**

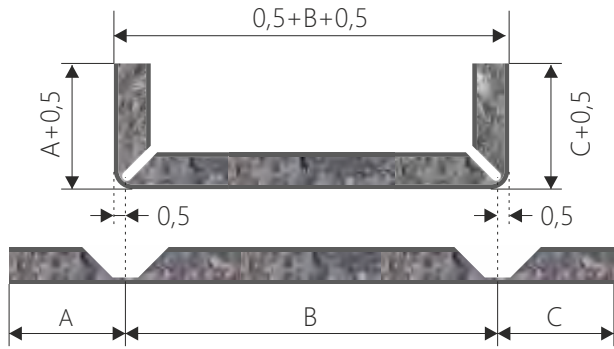

**CUTTING AND ROUTING OF THE CASSETTE**

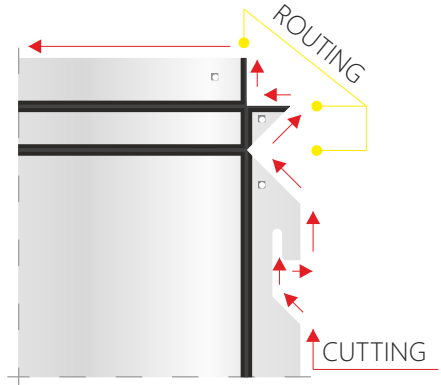

1. Cut and routing the panel according to the standard geometry.



2. Folding the upper and the bottom edges of the cassettes to 90°.



3. Folding the lateral edges and the triangular parts of the cassette to 90°.



4. Folding the upper edge against the edges folded previously.

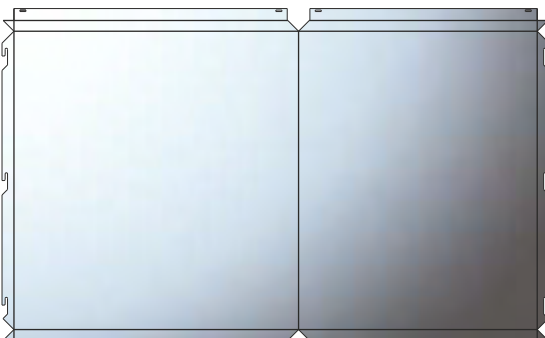

CORNER

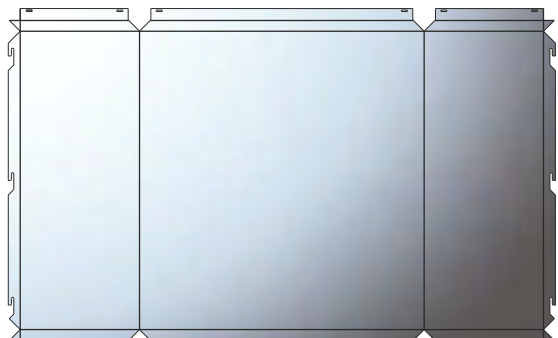

DOUBLE CORNER



#### 11.4. Curving.

##### GENERAL SPECIFICATIONS.

**Alucoil®** should make a preliminary evaluation to verify every curving solution desired by the clients in order to assure its accurate execution.

**larson®** composite panel can be curved easily in curving machines of three or four rolls, ensuring that they are clean to avoid damaging the material.

a) Curving of **larson®** of 3 or 4mm thickness.

Manufacturing dimensions:

- Curving maximum width: 4000 mm (curving machine length).
- Minimum radius: 150 mm.

b) Curving of **larson® Metals** stainless steel composite panels

Manufacturing dimensions:

- Curving maximum width: 4 m (Length of the curving machine).
- Minimum radius: 1000 mm.

c) Curving of 4mm thickness **larson®** cassette with folded edges.

Manufacturing dimensions:

- Minimum bending width: 150 mm (the same as the caps width). Distance between the caps will be the same as the thickness of the panel, so that separation is where the edges will move during the curving process.
- Curving maximum width: 4 m. (The limit of the pyramid roller).
- Maximum cassette route and return folds: 20 mm

##### NOTES FOR CURVING CASSETTES WITH EDGES:

- It is not recommended to curve cassettes with edges greater than 20 mm as they could become twisted.
- To carry out the curving process, it is required to place a 2 mm thick aluminium sheet between the panel and cap areas in order to avoid marking the teflón caps. If this sheet is not used, cap marks will appear on the panel surface.
- If the desired radius is greater than 1000 mm, curving can be performed flat, bending the edges afterwards. For this reason the initial curving radius should be smaller than the intended one, reaching the desired radius during the forming of the cassette. With this type of curving practice, the edge of the cassette will not remain completely flat some minor, subtle ripples will be visible on those edges.
- **larson® Metals** stainless steel can be curved in cassette form with edges of 40mm in the folding sense.
- Due to 3 mm composite panels low rigidity, it won't be possible to curve them on cassette form due to edge distortion during the process.

RADIUS (mm)	TOLERANCE (%)
150 < R < 1000	±7
1000 < R < 2000	±3.5
R > 2000	±2





### 11.5. **larson**® PERFORATED.

The ability to perforate and warrant **larson**® FR metal composite panels is a reality, opening up design possibilities unimaginable until now with a wide range of perforation combinations at your disposal. Whether by CNC or punching processes, **Alucoil**® offers the possibility to utilize round, square, triangular, star, and many other shapes in different perforation sizes and patterns. A warranty requires prior analysis of project specifics by **Alucoil**® in advance and is limited to panels manufactured in Miranda de Ebro, Spain.

- High quality 5005 series aluminum alloy.
- Corrosion-Resistant Pretreatment.
- Exceptional bond strength.
- Perforated for wall cladding (Double sided coated).
- Perforated Ceiling Panels (One side coated).
- Multiple Perforation Patterns.

As well as its use for wall cladding, the use of perforated composite panels for internal applications is a clear commitment to modern design. Non-perforated perimeter areas will be indicated by the type of perforation and tool used for each case. To combine different diameters within the same panel, or special dimensions and perforations, please consult. Based on below abbreviations to designate perforation configurations, **Alucoil**® offers a wide range of perforation patterns which provides each type of facade an exclusive design:

- "R": Round (diameter of perforations).
- "U": Parallel perforations (distance between axes).
- "T": Perforations in a staggered formation (distance between axes).
- "C": Square (side of square).
- "LC": Rectangle (width x length).
- "LR": Slotted holes (width x length).

LENGTH < 6000 mm - WIDE < 1500 mm								
<b>Round staggered</b>	R4T8,8	R5T9	R6T16	R7T17,5	R8T19	R10T14	R15T20	R20T27
<b>Rounded rectangular</b>	R4U8,8	R5U13	R6U16	R6U25	R7U17,5	R8U19	R10U24	R20U46,8
<b>Square rectangular</b>	C4U12	C8U21	C10U26	C20U40	C30U48	C30U60	C40U80	C70U140
<b>Diagonal square</b>	CD10M15				CD10U21			
<b>Square side in parallel</b>	LC4X20U26							

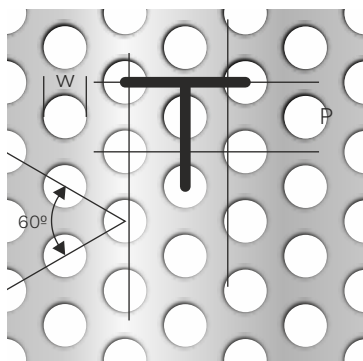

Rounded 60° Staggered (T)

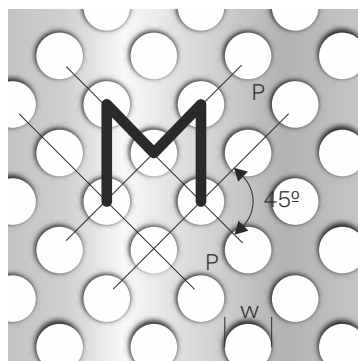

Rounded 45° Staggered (M)

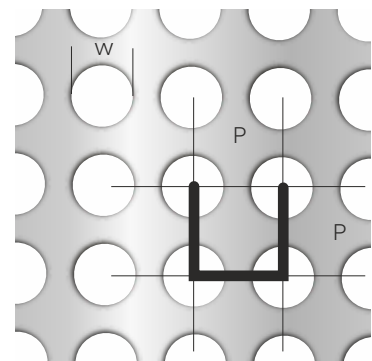

Rounded Rectangular Pitch (U)

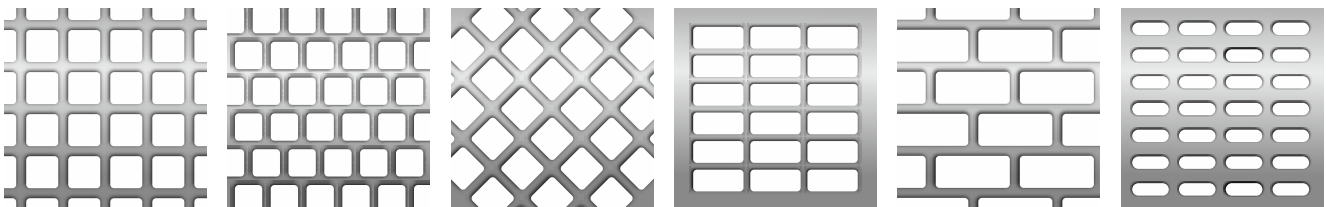



## ONLY EUROPE (EUROCODE)

### 12. Wind loads and pressure

#### Basis for calculation

The wind speed and the velocity pressure are composed of a mean and a fluctuating component. The mean wind velocity  $V_m$  should be determined from the basic wind velocity  $V_b$  which depends on the wind climate and the height variation of the wind determined from the terrain roughness and orography. The fluctuating component of the wind is represented by the turbulence intensity.

#### Basic values

The basic wind velocity shall be calculated from expression  $V_b = C_{dir} \cdot C_{season} \cdot V_{b,0}$

$V_b$  is the basic wind velocity

$V_{b,0}$  is the fundamental value of the basic wind velocity

$C_{dir}$  is the directional factor

$C_{season}$  is the season factor

#### Mean wind (variation with height)

The mean wind velocity  $V_m(z)$  at a height  $z$  above the terrain depends on the terrain roughness and orography and on the basic wind velocity,  $V_b$ .

$$V_m(z) = C_r(z) \cdot C_o(z) \cdot V_b$$

$C_r(z)$  is the roughness factor

$C_o(z)$  is the orography factor, taken as 1,0 unless otherwise specified.

#### Terrain roughness

The roughness factor,  $C_r(z)$ , accounts for the variability of the mean wind velocity at the site of the structure due to:

- 1.- The height above ground level.
- 2.- The ground roughness of the terrain upwind of the structure in the wind direction considered.

$$C_r(z) = k_r \cdot \ln(z/z_0) \text{ for } z_{min} \leq z \leq z_{max}$$

$$C_r(z) = C_r(z_{min}) \text{ for } z \leq z_{min}$$

$z_0$  is the roughness length

$k_r$  is the terrain factor depending on the roughness length  $z_0$  calculated using  $k_r = 0,19 (z_0 / z_{0,11})^{0,07}$

$z_{0,11} = 0,05m$  (terrain category II, table 1)

$z_{min}$  is the minimum height defined in table 1

$z_{max}$  is to be taken as 200 m

External pressure coefficients for vertical walls

Zone	A		B		C		D		E	
	$C_{pe,10}$	$C_{pe,1}$	$C_{pe,10}$	$C_{pe,1}$	$C_{pe,10}$	$C_{pe,1}$	$C_{pe,10}$	$C_{pe,1}$	$C_{pe,10}$	$C_{pe,1}$
h/d										
5	-1,2	-1,4	-0,8	-1,1	-0,5		+0,8	+1,0		-0,7
1	-1,2	-1,4	-0,8	-1,1	-0,5		+0,8	+1,0		-0,5
≤0,25	-1,2	-1,4	-0,8	-1,1	-0,5		+0,7	+1,0		-0,3

#### TERRAIN CATEGORY

	$z_0$ m	$z_{min}$ m
<b>0</b> Sea or coastal area exposed to the open sea.	0,003	1
<b>I</b> Lakes or flat and horizontal area with negligible vegetation and without obstacles.	0,01	1
<b>II</b> Area with low vegetation such as grass and isolated obstacles (trees, buildings) with separations of at least 20 obstacle heights.	0,05	2
<b>III</b> Area with regular cover of vegetation or buildings or with isolated obstacles with separations of maximum 20 obstacle heights (such as villages, suburban terrain, permanent forest).	0,3	5
<b>IV</b> Area in which at least 15% of the surface is covered with buildings and their average height exceeds 15m.	1,0	10

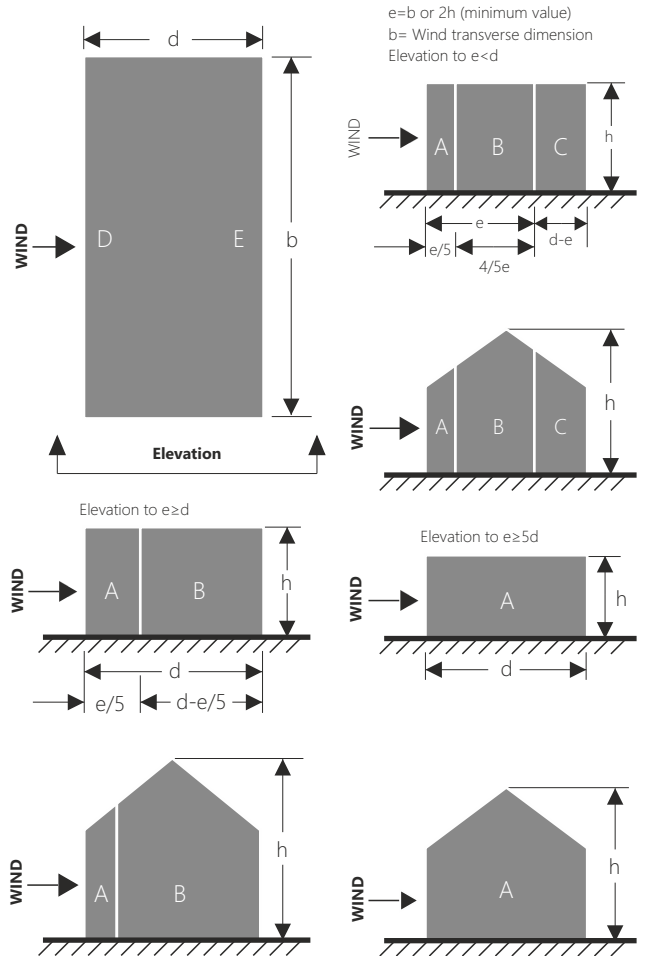

#### Peak velocity pressure $q_p(z) = C_e(z) \cdot q_b$

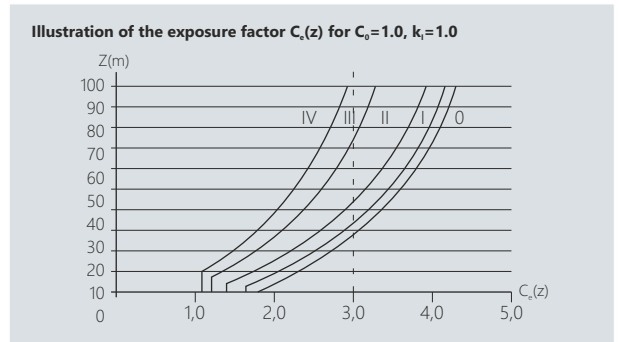

#### Wind pressure on surfaces $W_e = q_p(z_e) \cdot C_{pe}$

$z_e$  is the reference height for the external pressure  
 $C_{pe}$  is the pressure coefficient for the external pressure

The figure is based on the following: for  $1m^2 < A < 10m^2$

$$C_{pe} = C_{pe,1} (C_{pe,1} - C_{pe,10}) \log_{10} A$$

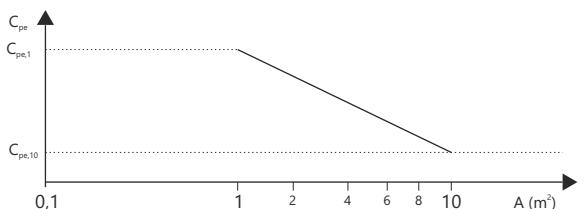



## ONLY IN SPAIN (CTE)

### 12. Acción del viento (DB SE-AE, CTE ESPAÑA)

La distribución y el valor de las cargas que ejerce el viento sobre una zona de la fachada de un edificio dependen de la forma y de las dimensiones de la construcción, de la altura, posición y dimensión del elemento de estudio, del entorno que rodea al edificio y de la zona eólica en que se encuentra.

La acción del viento (que se considera siempre perpendicular a cualquier superficie plana sobre la que actúe) viene definida por la siguiente fórmula:  $q_e = q_b \cdot c_e \cdot c_{pe}$ , siendo:

a)  $q_b$ : Presión dinámica del viento.

De forma simplificada se puede adoptar el valor de 0,5 kPa en cualquier punto de España, pero existe un mapa con tres zonas diferenciadas de velocidad básica del viento.

- Zona A: 26 m/s ( $q_b=422,500$  Pa)
- Zona B: 27 m/s ( $q_b=455,625$  Pa)
- Zona C: 29 m/s ( $q_b=525,625$  Pa)

b)  $C_e$ : En España existe una tabla con diferentes coeficientes de exposición para cada tipo de entorno, diferenciando claramente 5 grados de aspereza:

TABLA 1: Valores del coeficiente de exposición  $C_e$  (hasta 30 m).

Grado de aspereza del entorno	ALTURA DEL PUNTO CONSIDERADO (m)							
	3	6	9	12	15	18	24	30
<b>I.</b> Borde del mar o de un lago, con una superficie de agua en la dirección del viento de al menos 5km de longitud.	2,4	2,7	3,0	3,1	3,3	3,4	3,5	3,7
<b>II.</b> Terreno rural llano sin obstáculos ni arbolado de importancia.	2,1	2,5	2,7	2,9	3,0	3,1	3,3	3,53
<b>III.</b> Zona rural accidentada o llana con algunos obstáculos aislados, como árboles o construcciones pequeñas.	1,6	2,0	2,3	2,5	2,6	2,7	2,9	,1
<b>IV.</b> Zona urbana en general, industrial o forestal.	1,3	1,4	1,7	1,9	2,1	2,2	2,4	2,6
<b>V.</b> Centro de negocios de grandes ciudades, con profusión de edificios en altura.	1,2	1,2	1,2	1,4	1,5	1,6	1,9	2,0

c)  $c_p$ : Coeficiente eólico o de presión. Depende de la forma del edificio, de la posición de elemento considerado y de su área de

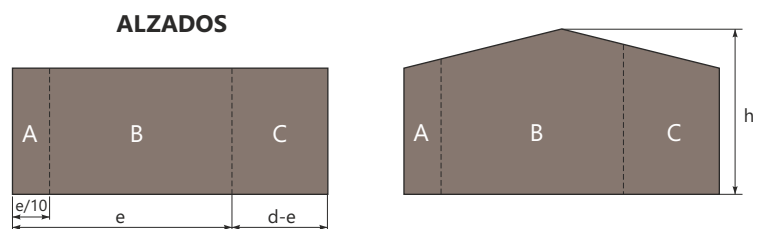

### PLANTA



TABLA 2: coeficientes eólicos para edificios de paramentos verticales en edificios de volumen prismático

Zona (según figura), $-45^\circ < \theta < 45^\circ$						
A (m <sup>2</sup> )	h/d	A	B	C	D	E
≥ 10	5	-1,2	-0,8	-0,5	0,8	-0,7
	1	"	"	"	"	-0,5
	≤ 0,25	"	"	"	0,7	-0,3
5	5	-1,3	-0,9	-0,5	0,9	-0,7
	1	"	"	"	"	-0,5
	≤ 0,25	"	"	"	0,8	-0,3
2	5	-1,3	-1,0	-0,5	0,9	-0,7
	1	"	"	"	"	-0,5
	≤ 0,25	"	"	"	0,7	-0,3
≤ 1	5	-1,4	-1,1	-0,5	1,0	-0,7
	1	"	"	"	"	-0,5
	≤ 0,25	"	"	"	"	-0,3

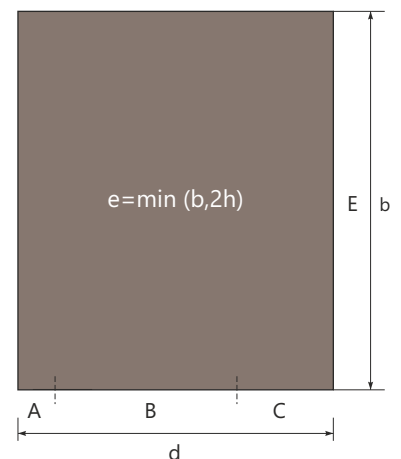

### 13. larson® behavior under wind loads.

**Alucoil®** installation systems and panels have achieved several European certificates, such as DIT (Spain), ETA (Europe), AVIS TECHNIQUE (France), DIBt (Germany) or BBA (UK), Intertek North America and CODEMARK Australia/NZ. To obtain all of them several tests have been carried out in order to know panels and cassettes behavior under different wind loads. These tests are performed simulating the entire installation system so that the results show the real deflection of our panel/cassette as well as the appearance of plastic deformation, if it existent, once the load has been removed.

To make panel and cassette calculations it is better to also define the substructure, it would be necessary to consider Service Limit State (for deflections), Ultimate Limit State (for stresses) and the following points:

- a) Aluminium composite panel **larson®** 4 mm thickness
- b) Maximum deflection in the middle of the cassette attending to project specifications.
- c) Maximum stress of composite panel = 80 MPa on the sheets
- d) Maximum deflection of vertical profile L/200 mm or 15 mm, where "L" is the distance between brackets.
- e) Wind load would be factorized by 1,5.

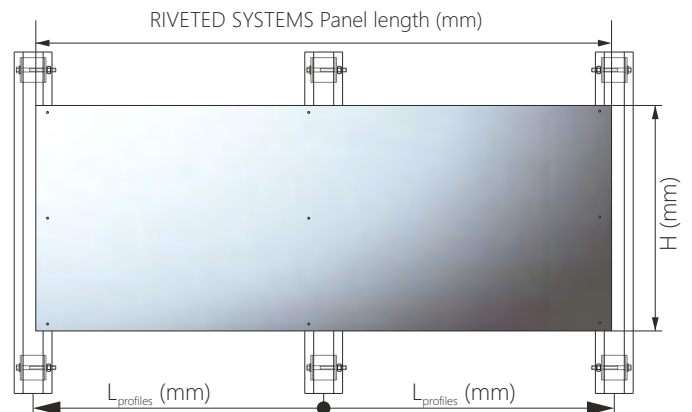
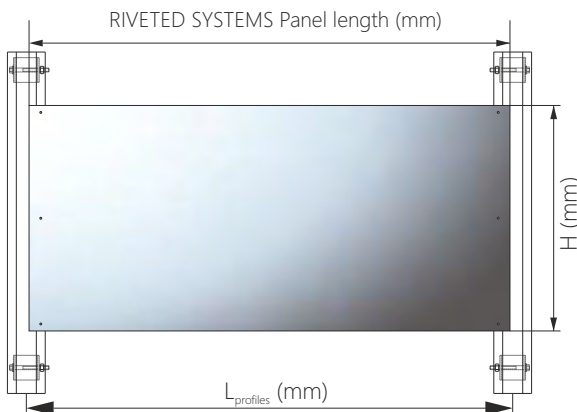
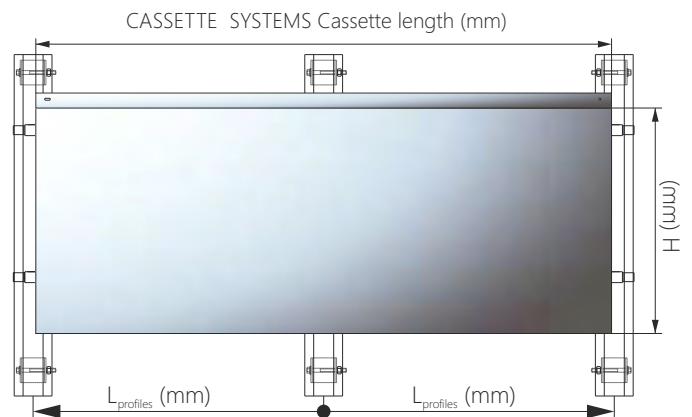
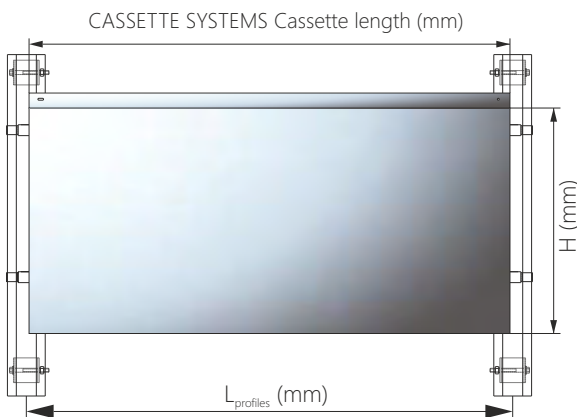

Distance between vertical profiles "L<sub>profiles</sub>"



**Only informative data. For final calculus please contact with the technical department of Alucoil®**

LCH-1 INSTALLATION SYSTEM (45 mm edge)  
 Cassette length "L" with 2, 3, 4, 5 and 6 vertical profiles - Height "H" 1500 mm

**NUMBER OF VERTICAL PROFILES**

	<b>2</b>	<b>3</b>	<b>4</b>	<b>5</b>	<b>6</b>
200 N/m <sup>2</sup>	1750 mm	3550 mm	5850 mm	7800 mm	8000 mm
600 N/m <sup>2</sup>	1100 mm	2350 mm	3850 mm	5133 mm	6417 mm
1000 N/m <sup>2</sup>	850 mm	1950 mm	3200 mm	4267 mm	5333 mm
1400 N/m <sup>2</sup>	750 mm	1700 mm	2800 mm	3733 mm	4667 mm
1800 N/m <sup>2</sup>	700 mm	1550 mm	2500 mm	3333 mm	4167 mm
2200 N/m <sup>2</sup>	650 mm	1450 mm	2300 mm	3067 mm	3833 mm
2600 N/m <sup>2</sup>	600 mm	1350 mm	2150 mm	2867 mm	3583 mm
3000 N/m <sup>2</sup>	550 mm	1300 mm	2050 mm	2733 mm	3417 mm

RIVETED INSTALLATION SYSTEM  
 Panel length "L" with 2, 3, 4, 5 and 6 vertical profiles - Height "H" 1500 mm

**NUMBER OF VERTICAL PROFILES**

	<b>2</b>	<b>3</b>	<b>4</b>	<b>5</b>	<b>6</b>
200 N/m <sup>2</sup>	2100 mm	4700 mm	6950 mm	8000 mm	8000 mm
600 N/m <sup>2</sup>	1350 mm	2900 mm	4450 mm	5933 mm	7417 mm
1000 N/m <sup>2</sup>	1100 mm	2100 mm	32300 mm	4400 mm	5500 mm
1400 N/m <sup>2</sup>	950 mm	1700 mm	2650 mm	3533 mm	4417 mm
1800 N/m <sup>2</sup>	900 mm	1450 mm	2250 mm	3000 mm	3750 mm
2200 N/m <sup>2</sup>	800 mm	1250 mm	1950 mm	2600 mm	3250 mm
2600 N/m <sup>2</sup>	750 mm	1100 mm	1750 mm	2333mm	2917 mm
3000 N/m <sup>2</sup>	700 mm	1000 mm	1600 mm	2133 mm	2667 mm



## 14. Cassettes from composite panels.

- 14.1. Standard cassette.
- 14.2. Cassette shaped.
- 14.3. Edge cassettes development.
- 14.4. Intermediate vertical stiffeners (PCI).
- 14.5. Intermediate horizontal stiffeners (LC-RH).
- 14.6. Screws & rivets.

14.1. Standard cassette is the cassette formed from **larson®** composite panel with the following characteristics:

- Upper edged of 40mm y 36mm
- Lower edged of 32mm
- Lateral edged of 44,5mm
- Upper slot separation=65mm
- Lower slot separation=100mm
- Hanging width (slot)=15mm

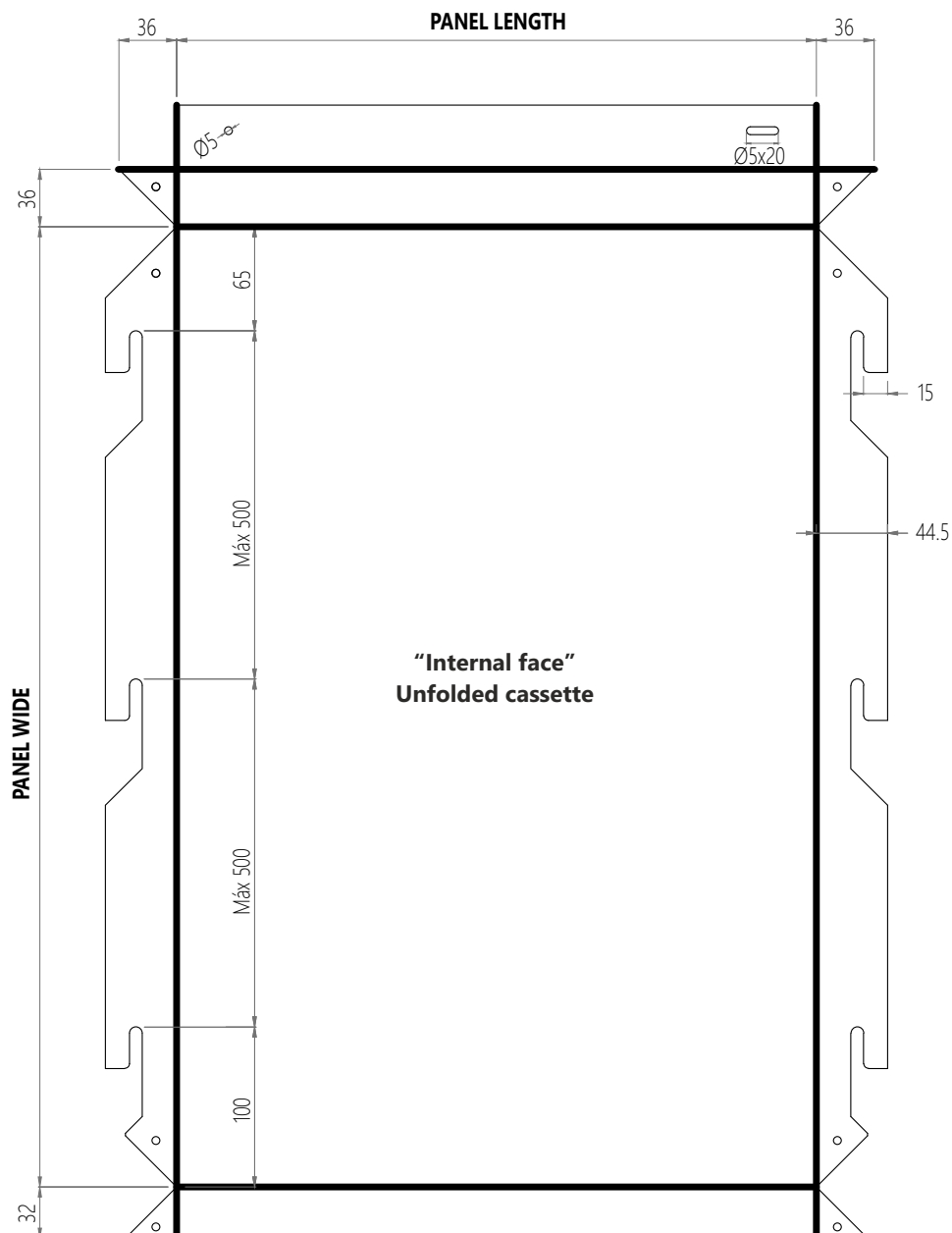



### 14.2. Cassette shaped.

Standard **larson®** cassette is formed using rivets to join the folded edges with LCR pieces or with aluminium plates.

According to different panel certifications, these rivets should be open ended blind rivets ISO 15977 - Ø4.8 x 12 AIA/St ( $d_k=9.5\text{mm}$ ) (DIN 7337).

With an A2 stainless steel break pull mandrel, diameter 4,8mm and length 12mm, and protruding aluminium head.

STANDARD BLIND RIVET Ø4,8 x 12 mm EN ISO 15977  
Dome head  
Body: Aluminium (Al Mg 3,5 EN AW 5154)  
Mandrel: Stainless steel (DIN EN 10016-2)

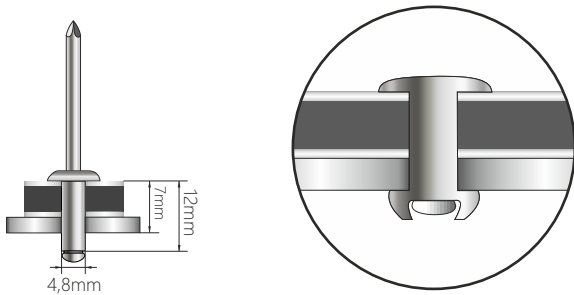

### 14.3. Cassettes edges development.

**larson®** cassette is formed by bending and folding its edges. These edges are folded in the middle of a previous routing groove made on the panel with different angles as seen before. The most important thing to take into account is knowing the real dimension of the cassettes before folding its edges.

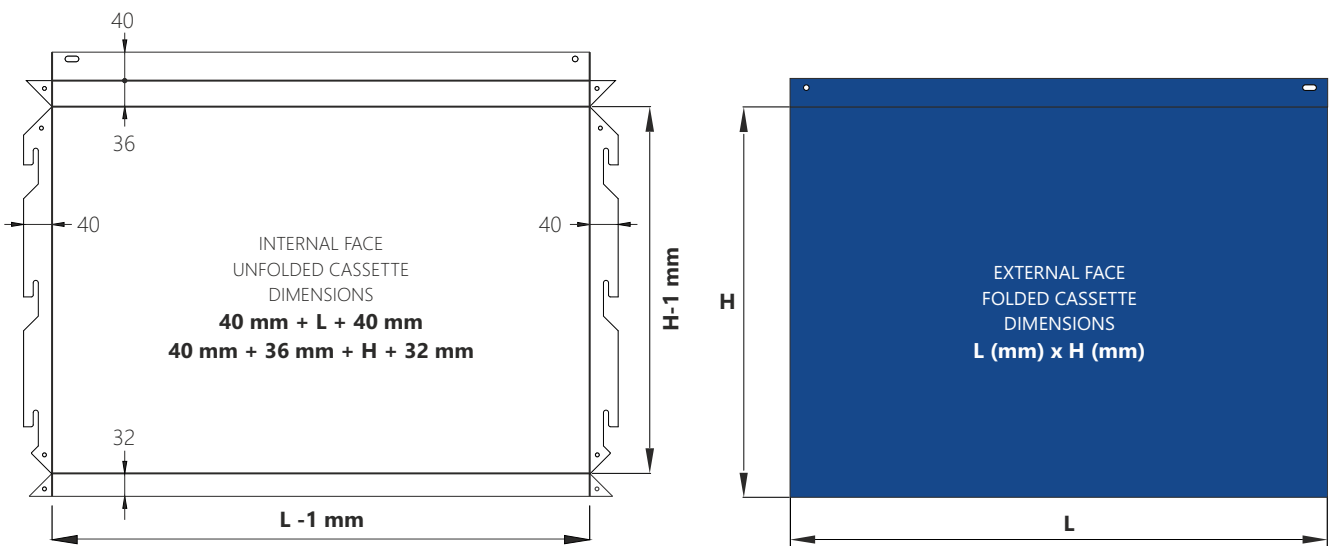



#### 14.4. Vertical stiffeners (PCI).

The PCI is usually made of pieces from Composite Panel. Using this piece it is possible to connect panels with intermediate modulation profiles, when it is necessary, by calculation.

##### a) Stiffener folding

The folding of the stiffener is made by a milling on the lacquered skin. The stiffener then will be folded so that the coated skin will remain inside, thus allowing gluing the stiffener NO coated face.

##### b) Primer application areas

Once clean, SikaTack® Panel Primer will be applied on both areas to strengthen the adhesion of the glue. The Sika® Aktivator 205 will be applied on the faces that will be in contact with both elements.

##### c) Double Sided tape

Once applied the primer on the area and having elapsed the primer timeout (30 '), proceed to place the SikaTack® Panel 3, double-sided adhesive tape which will support the PCI while the adhesive dries, plus ensuring the minimum thickness of glue on the stiffener.

Specifically, it must be located glued to the opposite edge that is folded.

##### d) Adhesive Application

The application of the SikaTack® Panel 50 adhesive will always on the PCI, applying a strip along the opposite edge to the one we stuck the double-sided tape, this time as close to the edge of the fold as possible.

##### e) Stiffener placement

The stiffener is positioned so that the leading edge with mechanized hangers stays perpendicular to the panel, and aligned with the theoretical axis of that stiffener.

Later their horizontal foldings will be riveted to upper and lower panel edges.

<sup>(\*)</sup>for **larson® Metals** panels, contact with the technical department.

PCI Cassette 44,5 mm COATED FACE

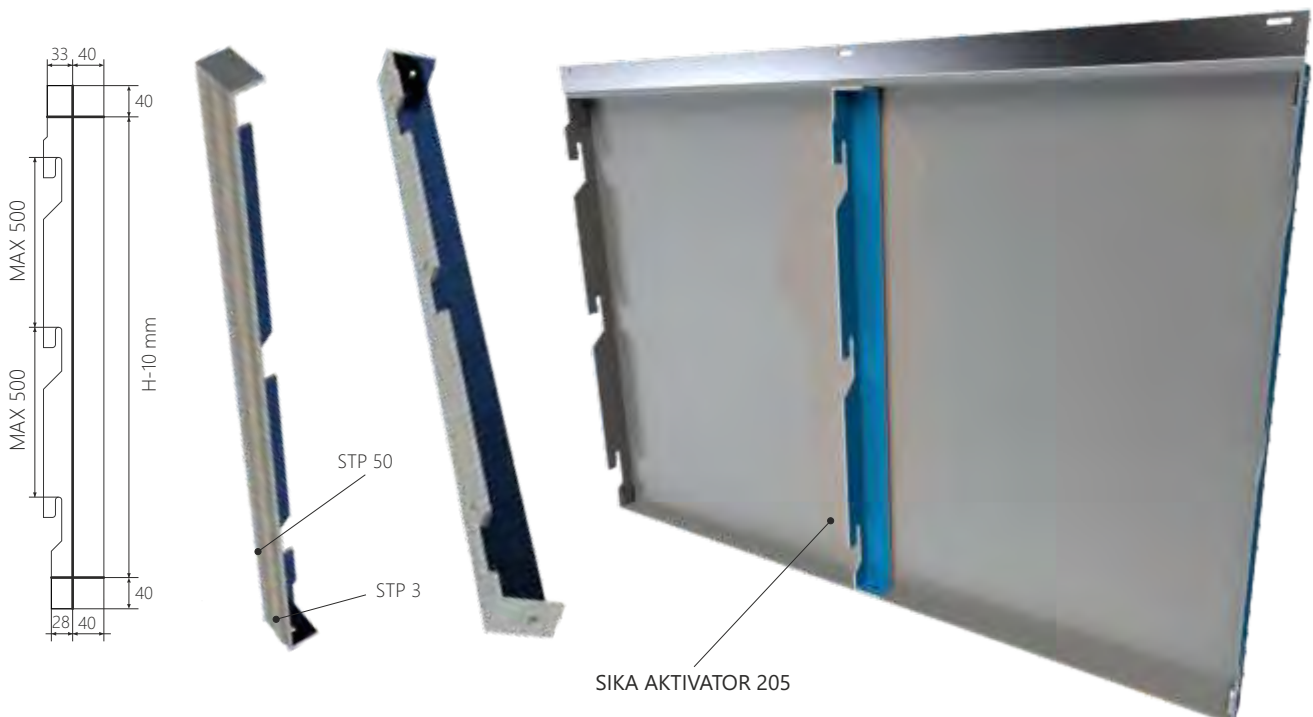



#### 14.5. Horizontal intermediate stiffeners (LC-RH).

They are used in vertical modulations when the wind load requires more substructure, and there is no aim or it is not possible to install intermediate profiles. It is an extruded aluminium profile which incorporates a screw holder to make easier the mechanical fixation to the edges of the panel. Calculations are required to determine the exact number of stiffeners needed, just as with vertical stiffeners.

##### Horizontal Stiffener features

- Machining limited to a simple cut.
- Glued system **SikaTack® Panel**.
- Screwed.
- It works better than those formed with composite panel.
- Lightweight.
- Easily assembled.

##### Glued system SikaTack® Panel

- Once clean, **SikaTack® Panel Primer** will be applied on both areas to strengthen the adhesion of the glue. The **Sika® Aktivator 205** will be applied on the faces that will be in contact with both elements.
- Place **SikaTack® Panel 3** tape at one end of the face to stick to the cassette the stiffener.
- Extend the triangular cord of **SikaTack® Panel 50** aided by the notch in the inside face in the center of LC-RH.
- Place the stiffeners helped by the mark on its external face.
- Drying will be 100% effective after 24 hours.

##### Attachments screws:

Screw fasteners used to attach stiffeners with the vertical edges should be: A2 stainless steel screws with thread sheet metal and extra flat head. Dimensions Ø4,2x22mm (ex.: screw INDEX CP-A2).

- A=**larson**® 4 mm
- B=Sikatack Panel 3
- C=Sikatack Panel 50
- D=LC-RH

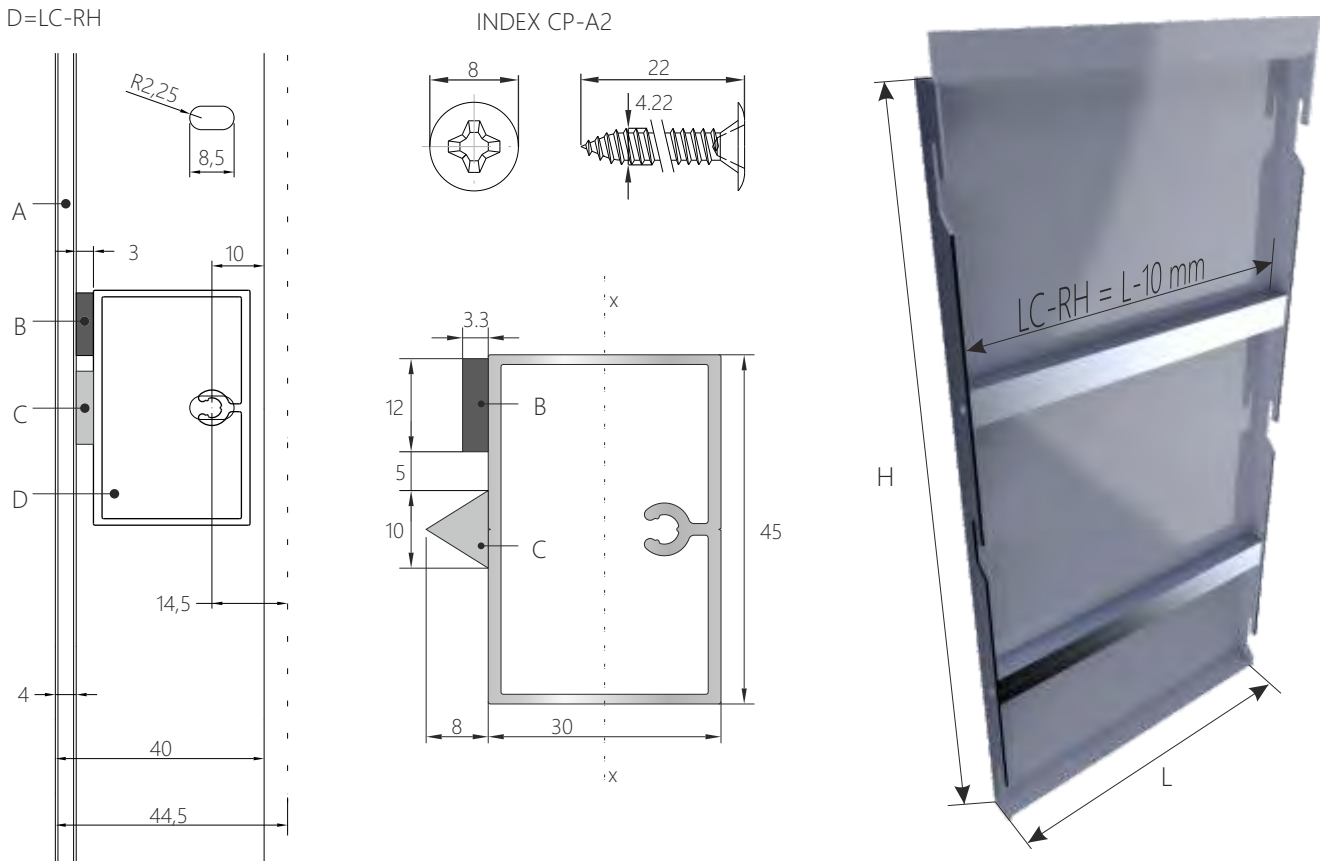



#### 14.6. Screws, rivets, nuts and washers.

##### Shaping cassettes.

a) Rivet ISO 15977 Ø4,8x12mm A1A/A2 (dk =9,5mm).

##### Fixing of the panels.

Perimetral riveted system.

a) Rivet ISO 15977 Ø5x12mm A1A/A2 (dk =14mm).

##### Fixing of the LC-13 with LCH-1 profiles.

Riveted system.

a) Rivet ISO 15977 Ø4,8x10mm A1A/A2 (dk =9,5mm).

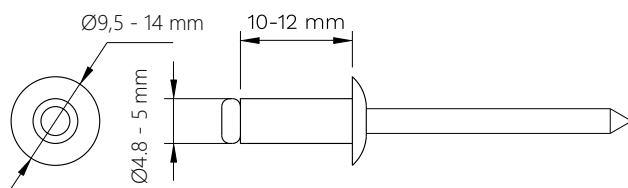

##### Fixing of the LC-3 piece and cassettes in its upper edge to the profiles.

LCH-1 and LC-2 system.

a) Self drilling screw DIN 7504-K Ø4,8x19mm A2/50 (also known as ISO 15480).

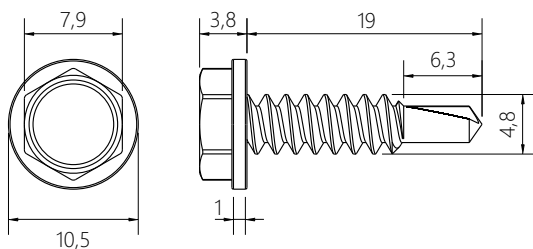

##### Fixing of the LCH-1 profile with the LCH-2 bracket.

a) Hex head screw DIN 933 M8x80mm 8.8. (also known as ISO 4017).

b) Washer DIN 125 M8 8.8 (also known as ISO 7089).

c) Hex nut DIN 934 M8 8. (also known as ISO 4032).

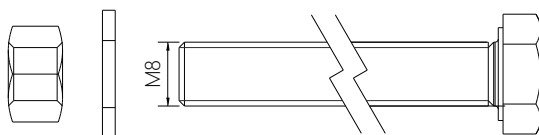

##### Fixing of the LC-2 profile to the LC-1 bracket.

LC-2 system and LC-9 system.

a) Hammer head screw UNE 17021 M8x17mm 4.8. Deltatone.

b) Hex nut DIN 6923 M8-4.8 (also known as ISO 1661).

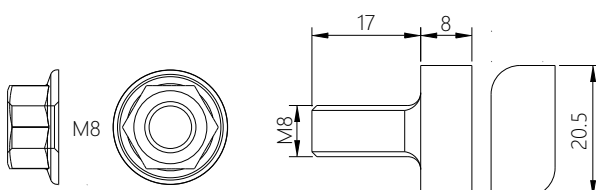





## 15. Inspection and maintenance guidelines.

This recommendation covers procedures for cleaning and maintaining coated aluminium roof covering and wall cladding. The information contains recommended methods as an aid in establishing safe, sound cleaning and maintenance practices with respect to coated aluminium roof covering and wall cladding.



### 15.1. General Considerations.

It is recommended that the building owner provide a qualified inspector who will see that the desired effect is being obtained with the use of sound cleaning and maintenance procedures. One inspection per year and associated cleaning of all areas is required for Limited Warranty coverage (cleaning and maintenance records should be kept and made available to **Alucoil**® if they are required).

Cleaning is vital in areas where industrial deposits have dulled the surface, where materials from construction processes have soiled the surface or where cleaner run-down from other surfaces should be removed. Local conditions as well as building location within a geographical area quite naturally have an effect on cleanliness.

#### **Regular inspection and maintenance should consist of:**

- Checking the condition of the sealants, fasteners and flashings to ensure water tightness.
- Examining local defects (e.g. scratches) that may cause early deterioration of the coating or corrosion of the substrate.
- Removing any blockage in gutters to avoid overflow or buildup.
- Removal of leaves, grass, mould and other objects and debris.
- Removal of dirt in areas of cladding not rinsed naturally by rainwater.
- Removal of graffiti or other marks.

Cleaning of coated aluminium may be scheduled with other cleaning. For example, glass and painted aluminium components can be cleaned at the same time. Cleaning is specifically required in areas of low rainfall or in industrialized areas. Foggy coastal regions with cycles of condensation and drying may tend to cause a build-up of atmospheric salts and dirt. In any climate, sheltered areas, such as overhangs, may become soiled due to insufficient rainwater rinsing. Thorough rinsing is especially important after cleaning of these sheltered areas. If automatic or pressure-based wall cleaning equipment is to be used on a building, a test should be made early in equipment design to ensure that the cleaning solutions, brushes, as well as the frequency of cleaning should be taken into consideration to ensure no detrimental effect on or to the coating.

After completion of the building, special attention should be paid to fixings, damages to the coating, drilling swarf, pop rivet systems and general building debris. Construction soils, including concrete or mortar, etc. should be removed as soon as possible. The exact procedure for cleaning will vary depending on the nature and degree of soil. Try to restrict cleaning to mild weather. Cleaning should be done on the shaded side of the building or ideally on a mild, cloudy day. Method of cleaning, type of cleaner, etc. of one component of the building must be used with consideration for other components such as glass, sealant, painted surfaces, etc.



## 15.2. Cleaning

- Removal of light surface soil:

Removal of light surface soil may be accomplished in several ways. Some testing is recommended to determine the degree of cleaning actually necessary to accomplish the task. Ideally, an initial step of forceful water rinse from the top down is recommended prior to any cleaner application. Significant benefit is gained with some type of surface agitation. Low water volume with moderate pressure is much better than considerable volume with little pressure. Physical rubbing of the surface with soft, wet brushes, sponges or cloth is also helpful.

The simplest procedure would be to apply the water rinse with moderate pressure to dislodge the soil. If this does not remove the soil, then a concurrent water spray with brushing or sponging should be tested. If soil is still adhering after drying, then a mild detergent will be necessary. When a mild detergent (PH7) or mild soap is necessary for removal of soil, it should be used with brushing or sponging. The washing should be done with uniform pressure, cleaning first with a horizontal motion and then with a vertical motion. Apply cleaners only to an area that can be conveniently cleaned without changing position. The surface must be thoroughly rinsed with clean water. It may be necessary to sponge the surface while rinsing, particularly if cleaner is permitted to dry on the surface. The rinsed surface can be air dried or wiped dry with a chamois, squeegee or lint free cloth. Run down of cleaner (from any operation) to the lower portions of the building should be minimized and these areas should be rinsed as soon as and as long as necessary to reduce streaking etc. from unavoidable run down. Do not allow cleaning chemicals to collect on surfaces or to "puddle" on horizontal surfaces, crevices, etc.

These areas should be flushed with water and dried via air or wiped dry with a chamois, squeegee or lint free cloth.

Always clean coated surfaces down from top to bottom and follow with a thorough rinsing with clean water. (With one storey or low elevation buildings, it is recommended to clean from bottom up and rinse from top down). To avoid water stain, the surface should be wiped.

- Cleaning of medium to heavy soil:

Some type of mild solvent such as mineral spirits may be used to remove grease, sealant or caulking compounds. Stronger solvent or solvent containing cleaners may have a deleterious or softening effect on coatings; accordingly, great care should be taken. To prevent harm to the finish, these types of solvent or emulsion cleaners should be soap tested and preferably the coating manufacturer should be consulted. Care should be taken to assure that no marring of the surface is taking place in this manner since this could cause an undesirable appearance at certain viewing angles. Cleaners of this type are usually applied with a clean cloth and removed with a cloth. Remaining residue should be washed with mild soap and rinsed with water. Use solvent cleaners sparingly. It may be possible for solvents to extract materials from sealants which could stain the painted surface or could prove harmful to sealants; therefore, possible adverse effects must be considered. Test clean a small area first.

- If cleaning of a heavy surface soil has been postponed or in cases of tenacious soil, stubborn stains, etc., then a more aggressive cleaner and technique may be required. Cleaner and technique should be matched to the soil and the painted finish. Some local manual cleaning may be needed at this point.

Always follow the recommendations of the cleaner manufacturer as to proper cleaner and concentration. Test clean a small area first. Cleaners should not be used indiscriminately. Do not use excessive, abrasive rubbings as such may alter surface texture or may impart a "shine" to the surface. Concrete spillage that has dried on the coated surface may become quite difficult to remove. Special cleaners and/or vigorous rubbing with non-abrasive brushes or plastic scrapers may be necessary. Diluted solutions of Muriatic Acid (under 10%) may be effective in removing dried concrete stains; however, a small test clean area should be tried first, and proper handling precautions must be exercised for safety reasons.

Never mix cleaners. Doing so may be ineffective, and worse, very dangerous. For example, mixing chlorine containing materials, such as bleaches, with other cleaning compounds containing ammonia can cause poisonous gas emissions. Always rinse the coated material after removal of heavy surface soil.

### Summary of general cleaning tips

- Overcleaning or excessive rubbing can do more harm than good.
- Strong solvents or strong cleaner concentrations can cause damage to painted surfaces.
- Avoid abrasive cleaners. Do not use household cleaners that contain abrasives on painted surfaces.
- Abrasive materials such as steel wool, abrasive brushes, etc. can wear and harm finishes.
- Avoid drips and splashes. Remove run downs as quickly as possible.
- Cleaning should be done in shade at moderate temperatures. Avoid temperature extremes. Heat accelerates chemical reactions and may evaporate water from solution. Extremely low temperature may give poor cleaning effects. Cleaning under adverse conditions may result in streaking or staining.
- Do not substitute a heavy duty cleaner for a frequently used mild cleaner.
- Do not scour coated surfaces.
- Never use paint removers, aggressive alkaline, acid or abrasive cleaners, phosphate or highly alkaline or highly acid cleaners.
- Follow manufacturers recommendations for mixing and diluting cleaners.
- Never mix cleaners.
- To prevent marring, make sure cleaning sponges, cloth etc. are grit free.
- Always test clean small surface.
- "An ounce of prevention is worth a pound of cure".



### 15.3. Repair.

Damage may be found on the surface of the coating when cleaning or otherwise maintaining the coated roof covering or wall cladding. Paint repair should be restricted to small areas (max. 5,0 m<sup>2</sup>).

Any significant repair work should be informed **Alucoil**<sup>®</sup>!

#### Execution when no corrosion is found:

- The damaged surface should be washed and dried as described above.
- A recommended touch-up paint should be applied for protective and aesthetic reasons.

#### Execution with small corrosion defects:

- Remove the dust by abrading, scraping, and sand blasting to the bare material.
- Degrease the complete surface.
- Clean and dry the surface (as described above) before applying a repair paint system (primer and top coat) recommended by the material supplier.

### 15.4. Re painted.

If it is deemed necessary to re-paint or reclad large surfaces, contact **Alucoil**<sup>®</sup> before execution.

Investigating the economic feasibility of over-painting the existing structure or replacing the coated sheets is recommended. In case of any questions about overpainting please contact us. Using non-compatible systems of repair paints and original coated surfaces might cause undesired effects.





## **16. Organisation of the works.**

### **16.1. Transport, storage and manipulation.**

The maximum storage period is eight months. It is recommended to stack panels horizontally one on top of the other, avoiding storage in the upright position.

Each stack shall contain a maximum of six pallets and may not exceed 10000 kg. It is recommended not to remove the protective film until after installation on the worksite.

### **16.2. Project design.**

Firstly, the condition of the support must be verified in both new building and retrofitting.

The anchoring brackets are then installed followed by the thermal insulation if possible (rigid hydrophobic and flame-retardant plates are recommended) before installation of the uprights.

The general part of the cladding is then installed from the bottom up (blank parts) and finally the intersection trays (corners, singular points, etc.).

### **16.3. Installers.**

Installation of the system may be performed by the beneficiary or by specialised companies approved by the former.

### **16.4. Preparation of the support.**

The substructure must be perfectly aligned in order to ensure flatness of the cladding system.

Before mounting the board system the anchor points must be subjected to an in situ pull-out test to ensure the stability and bearing capacity of the support structure.

The façade installer shall check the state of the support and approve the flatness of the same before mounting the system, which must be installed with proper levelling and vertical alignment to ensure that the final cladding is properly flat.

### **16.5. Cassettes.**

Care must be taken to install the trays in the right direction (marked with an deflection on the protective film and on the concealed side).

The protective film shall be removed once the façade is finished to prevent excessive exposure to sunlight and the elements from making later removal more difficult.

The first step for installation on the worksite is layout of the LC-3 hanger positions and subsequently, provided the distribution so permits, installation of the trays by rows and always from the bottom up, placing the notches on the LC-3 hanger.

Next, rivet the trays to the upright flanges and slotted holes located in the double fold of the top horizontal edge. If the trays require stiffeners fixed to the extrados with adhesive it is recommended to wait 24 hours to ensure proper curing of the adhesive before installing the cassette in its final position.

### **16.6. Panels.**

Care must be taken to install the trays in the right direction (marked with an arrow on the protective film and on the concealed side). The protective film shall be removed once the façade is finished to prevent excessive exposure to sunlight and the elements from making later removal more difficult.

#### 16.6.1. Panels with perimeter riveting.

The first step for installation on the worksite is mounting the substructure, laying out the position of the T-shaped connectors (ref LC-13) and subsequently, provided the distribution so permits, installation of the panels by rows and always from the bottom up, riveting them to the flanges of both the vertical and horizontal LCH-1 profiles.

#### 16.6.2. Vertically riveted panels.

Provided the layout so permits, installation of the panels by rows and always from the bottom up, riveting them to the flanges of the vertical LCH-1 profiles.



# **larson**®

Installation system - **LCH-1 cassettes**

Installation system - **LC4-LC6 cassettes**

Installation system - **RIVETED panels**

It would be customer responsibility to verify that any product supplied complies with applicable regulations related to product installation, and, in particular, with any regulations regarding fire resistance and fire reaction.

The information and measures contained in this document are for conceptual and theoretical use only. **Alucoil**® shall have no responsibility for these products usage and installation.

The inappropriate use and total or partial reproduction is forbidden, except if expressly authorized by **Alucoil**® S.A.U.

Panel design, transformation and transformation and installation are the sole responsibility of the purchaser.

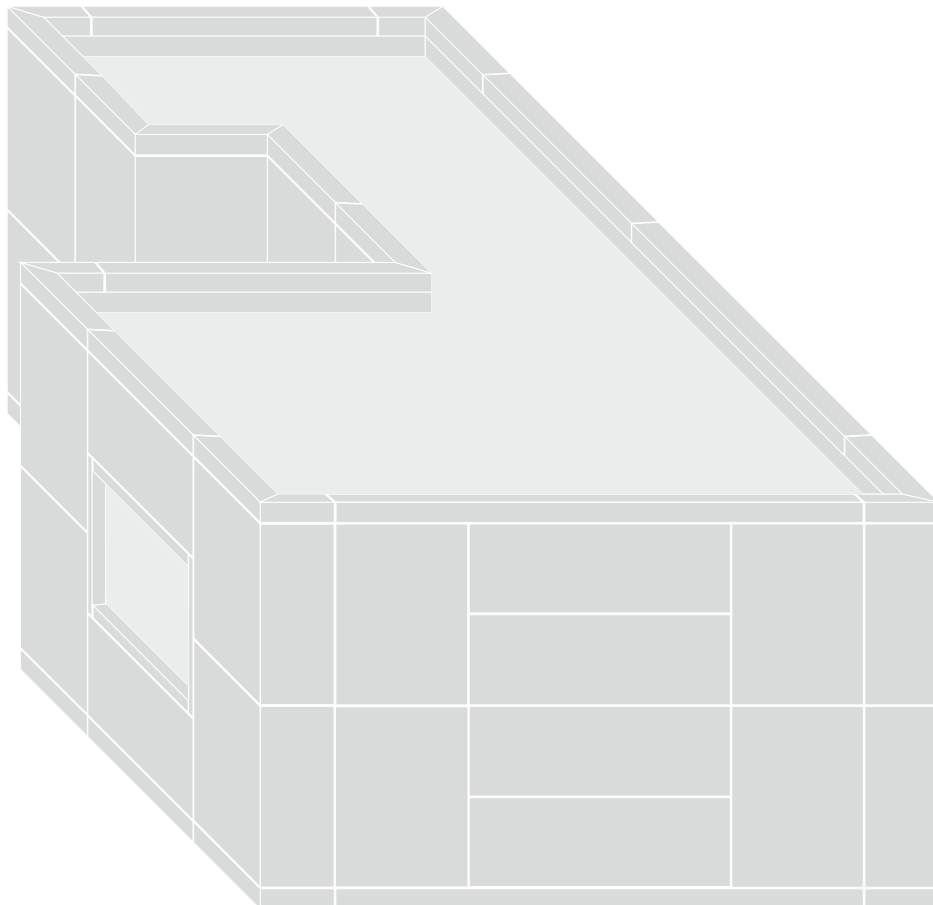



LCH-1 system "larson® cassettes".

**01. Outside elevation.**

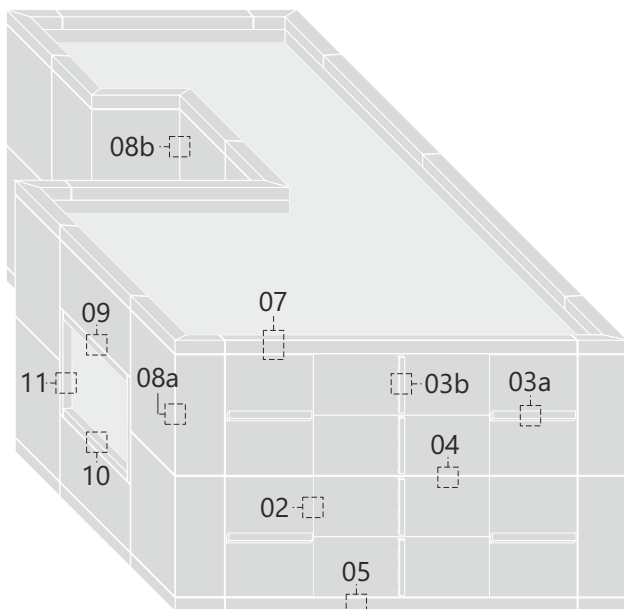
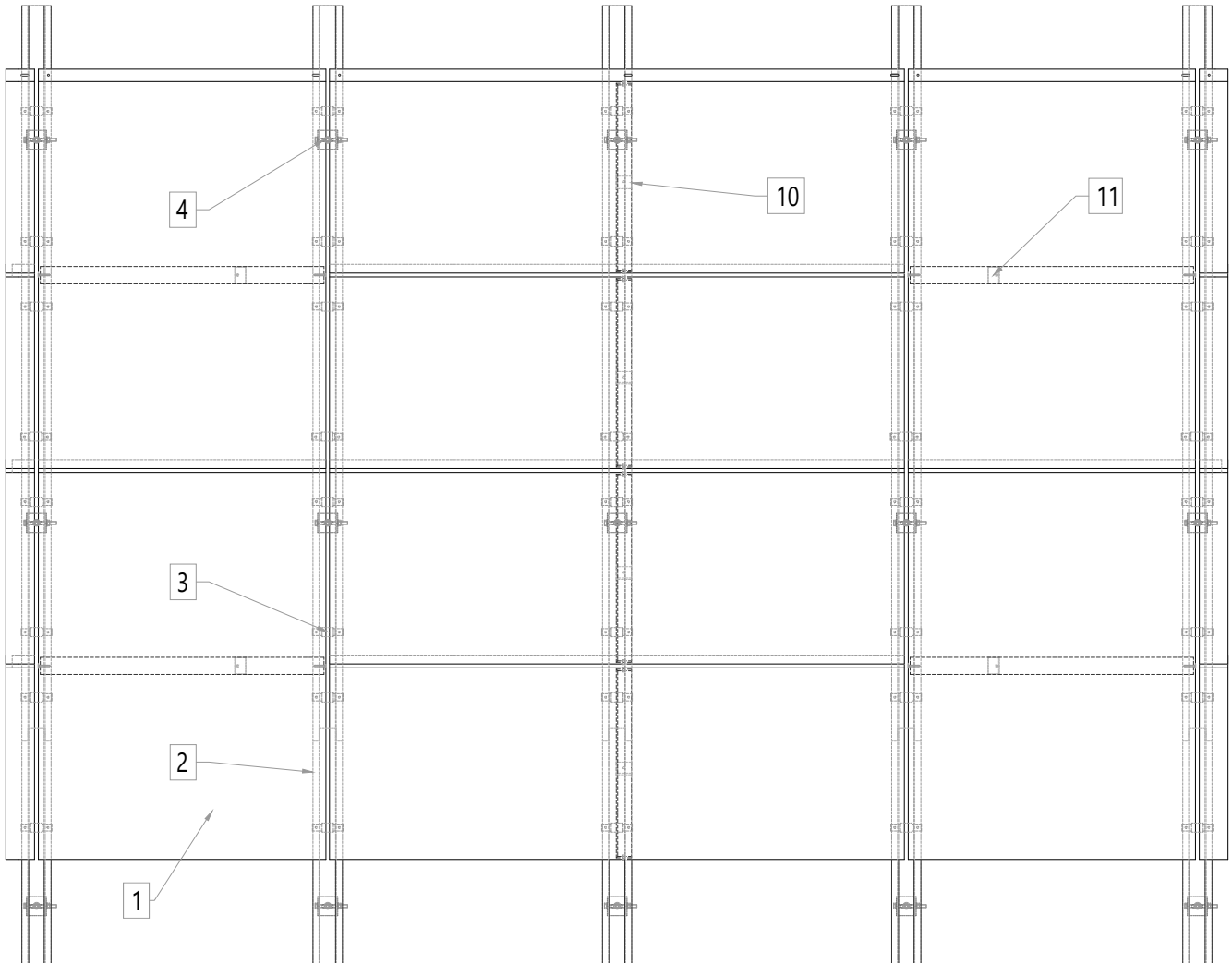

- 1.** larson® composite panel
- 2.** LCH-1 vertical profile
- 3.** LC-3 hanging piece with elastomer
- 4.** LCH-2 bracket
- 5.** 2-3 mm aluminium plate
- 6.** Screw DIN 933 M8x80 mm 8.8  
Washer DIN 125 M8 8.8 (x2)  
Hex nut DIN 934 M8 8.8
- 7.** Blind rivet ISO 18977 4.8x12 mm A1A/A2 (dk 8.5 mm)
- 8.** Self drilling screw DIN 7504-K4.8x22 mm A2/50
- 9.** Flat head self-tapping screw 4.2x22 mm A2/50
- 10.** Intermediate vertical stiffener PCI
- 11.** Intermediate horizontal stiffener LC-RH
- 12.** Elastomer
- 13.** SIKATAK PANEL 3 double-sided tape
- 14.** SIKATAK PANEL 50 structural silicone

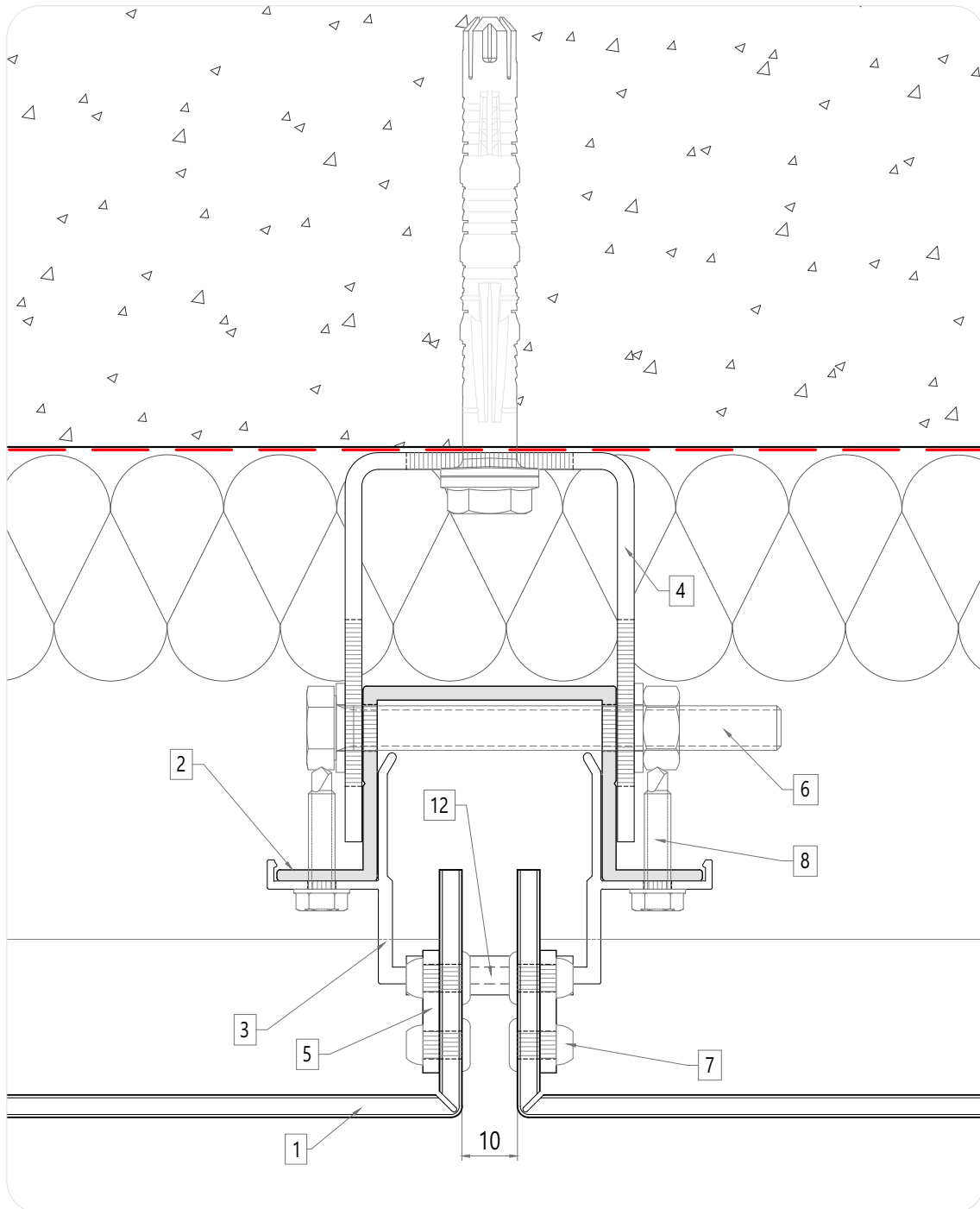

## 02. Vertical joint

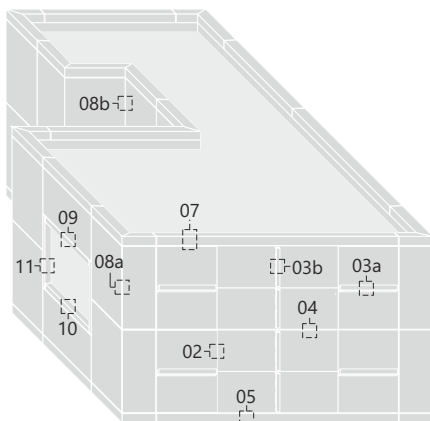

1. **larson®** composite panel
2. LCH-1 vertical profile
3. LC-3 hanging piece with elastomer
4. LCH-2 bracket
5. 2-3 mm aluminium plate
6. Screw DIN 933 M8x80 mm 8.8  
Washer DIN 125 M8 8.8 (x2)  
Hex nut DIN 934 M8 8.8
7. Blind rivet ISO 18977 4.8x12 mm A1A/A2 (dk 8.5 mm)
8. Self drilling screw DIN 7504-K4.8x22 mm A2/50
9. Flat head self-tapping screw 4.2x22 mm A2/50
10. Intermediate vertical stiffener PCI
11. Intermediate horizontal stiffener LC-RH
12. Elastomer
13. SIKATAACK PANEL 3 double-sided tape
14. SIKATAACK PANEL 50 structural silicone

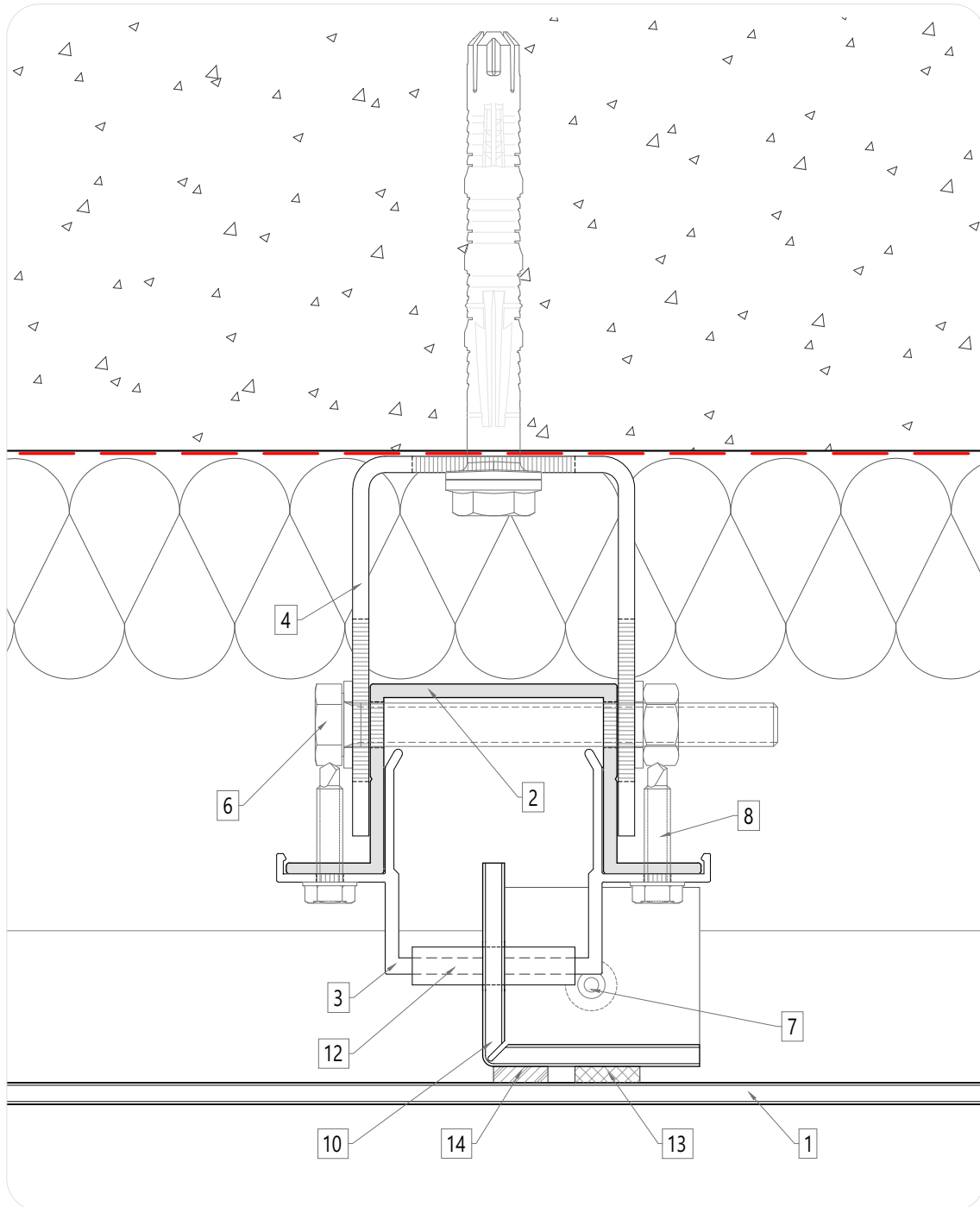

### 03a. LC-RH horizontal stiffener

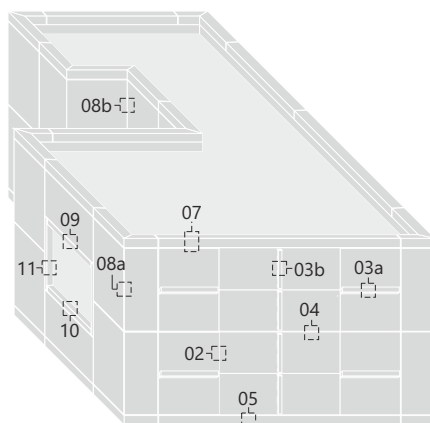

1. **larson®** composite panel
2. LCH-1 vertical profile
3. LC-3 hanging piece with elastomer
4. LCH-2 bracket
5. 2-3 mm aluminium plate
6. Screw DIN 933 M8x80 mm 8.8  
Washer DIN 125 M8 8.8 (x2)  
Hex nut DIN 934 M8 8.8
7. Blind rivet ISO 18977 4.8x12 mm A1A/A2 (dk 8.5 mm)
8. Self drilling screw DIN 7504-K4.8x22 mm A2/50
9. Flat head self-tapping screw 4.2x22 mm A2/50
10. Intermediate vertical stiffener PCI
11. Intermediate horizontal stiffener LC-RH
12. Elastomer
13. SIKATAACK PANEL 3 double-sided tape
14. SIKATAACK PANEL 50 structural silicone



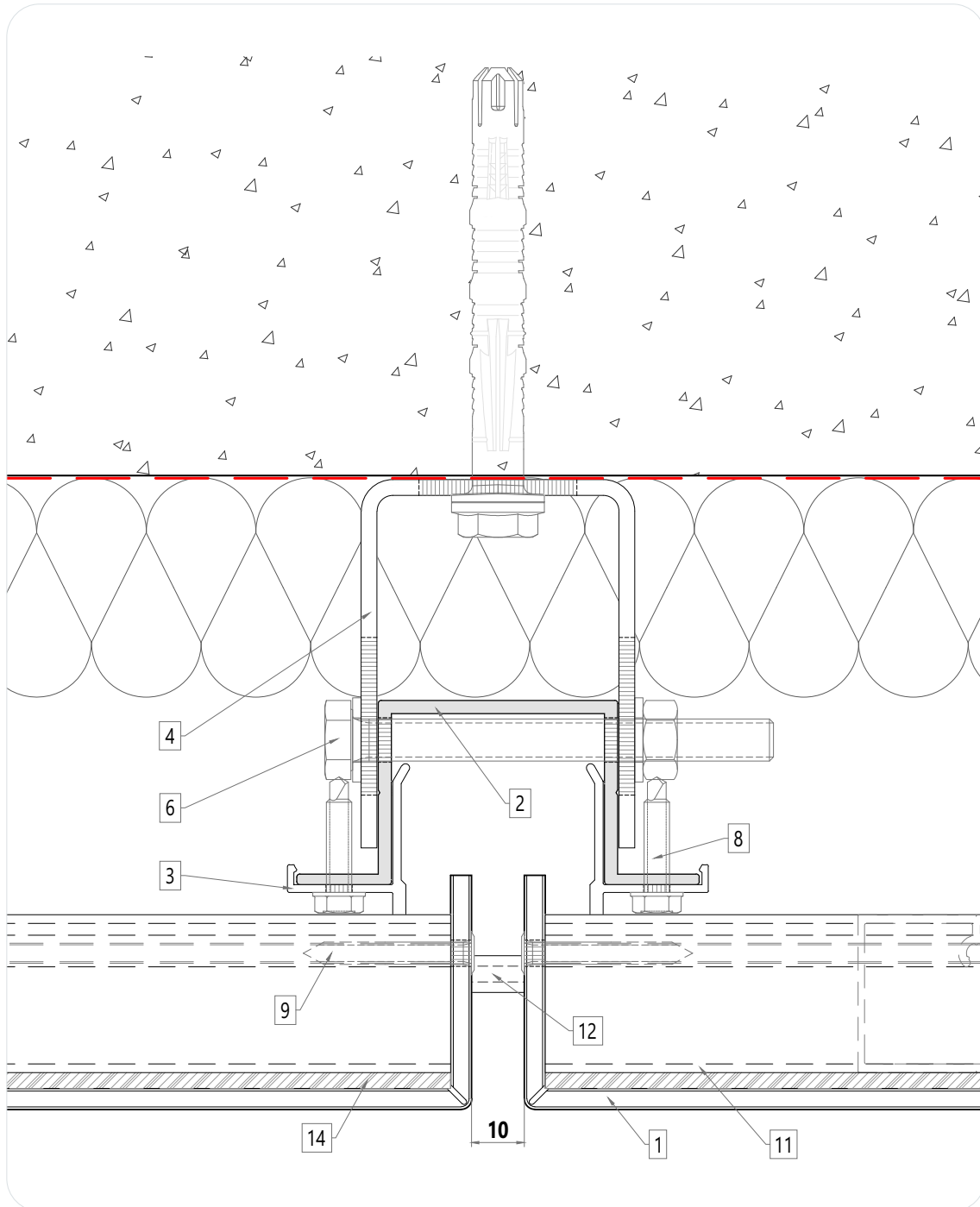

### 03b. PCI vertical stiffener

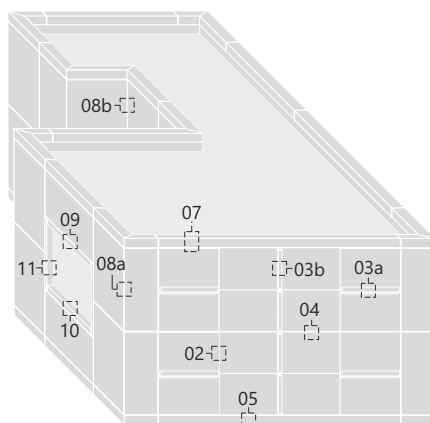

1. **larson®** composite panel
2. LCH-1 vertical profile
3. LC-3 hanging piece with elastomer
4. LCH-2 bracket
5. 2-3 mm aluminium plate
6. Screw DIN 933 M8x80 mm 8.8  
Washer DIN 125 M8 8.8 (x2)  
Hex nut DIN 934 M8 8.8
7. Blind rivet ISO 18977 4.8x12 mm A1A/A2 (dk 8.5 mm)
8. Self drilling screw DIN 7504-K4.8x22 mm A2/50
9. Flat head self-tapping screw 4.2x22 mm A2/50
10. Intermediate vertical stiffener PCI
11. Intermediate horizontal stiffener LC-RH
12. Elastomer
13. SIKATAK PANEL 3 double-sided tape
14. SIKATAK PANEL 50 structural silicone

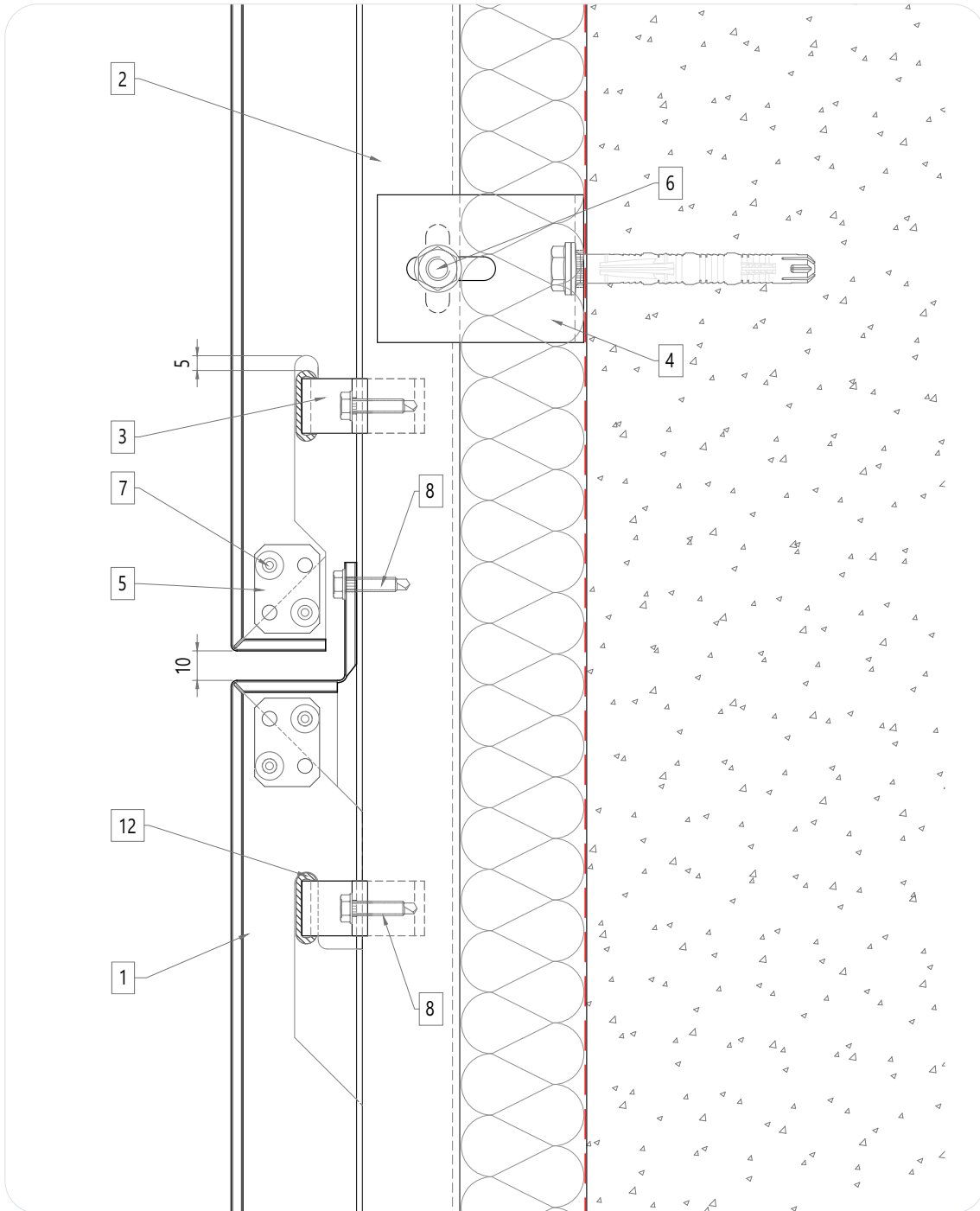

#### 04. Horizontal joint

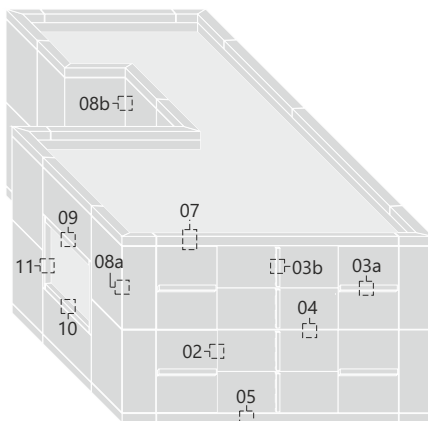

- 1. larson® composite panel
- 2. LCH-1 vertical profile
- 3. LC-3 hanging piece with elastomer
- 4. LCH-2 bracket
- 5. 2-3 mm aluminium plate
- 6. Screw DIN 933 M8x80 mm 8.8  
Washer DIN 125 M8 8.8 (x2)  
Hex nut DIN 934 M8 8.8
- 7. Blind rivet ISO 18977 4.8x12 mm A1/A2 (dk 8.5 mm)
- 8. Self drilling screw DIN 7504-K4.8x22 mm A2/50
- 9. Flat head self-tapping screw 4.2x22 mm A2/50
- 10. Intermediate vertical stiffener PCI
- 11. Intermediate horizontal stiffener LC-RH
- 12. Elastomer
- 13. SIKATAK PANEL 3 double-sided tape
- 14. SIKATAK PANEL 50 structural silicone

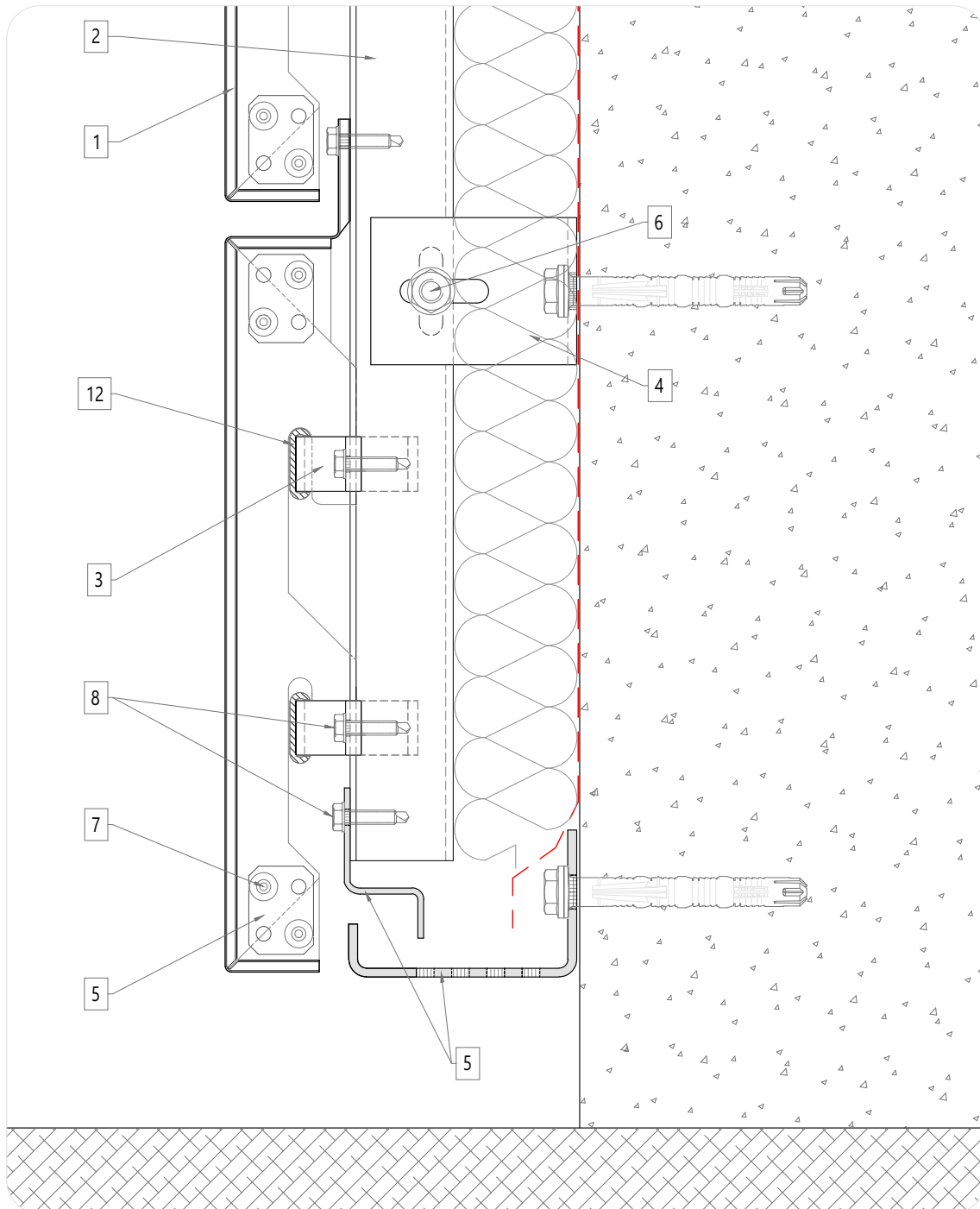

## 05. Façade starting

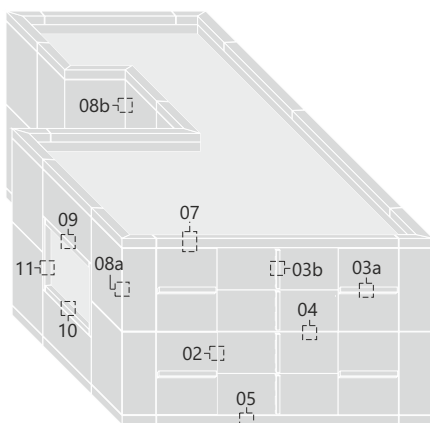

1. **larson®** composite panel
2. LCH-1 vertical profile
3. LC-3 hanging piece with elastomer
4. LCH-2 bracket
5. 2-3 mm aluminium plate
6. Screw DIN 933 M8x80 mm 8.8  
Washer DIN 125 M8 8.8 (x2)  
Hex nut DIN 934 M8 8.8
7. Blind rivet ISO 18977 4.8x12 mm A1A/A2 (dk 8.5 mm)
8. Self drilling screw DIN 7504-K4.8x22 mm A2/50
9. Flat head self-tapping screw 4.2x22 mm A2/50
10. Intermediate vertical stiffener PCI
11. Intermediate horizontal stiffener LC-RH
12. Elastomer
13. SIKATAK PANEL 3 double-sided tape
14. SIKATAK PANEL 50 structural silicone

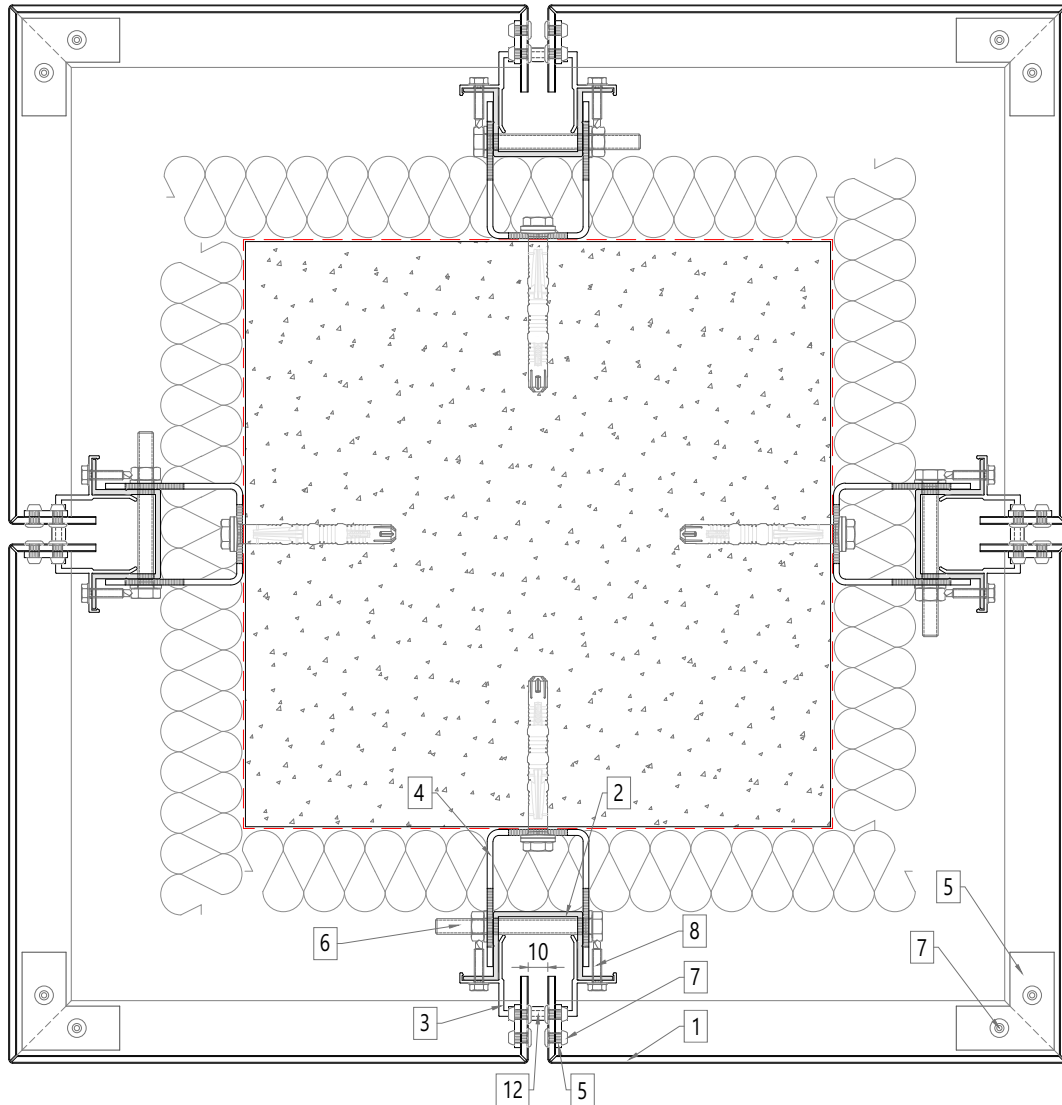

## 06. Columns

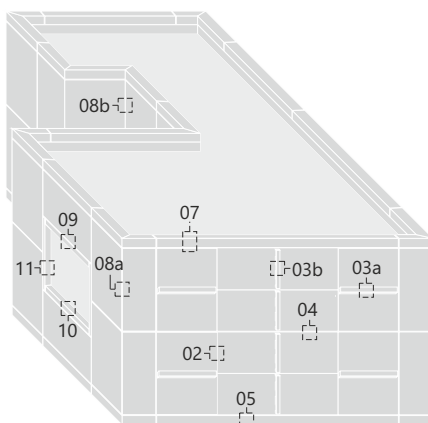

1. **larson®** composite panel
2. LCH-1 vertical profile
3. LC-3 hanging piece with elastomer
4. LCH-2 bracket
5. 2-3 mm aluminium plate
6. Screw DIN 933 M8x80 mm 8.8  
Washer DIN 125 M8 8.8 (x2)  
Hex nut DIN 934 M8 8.8
7. Blind rivet ISO 18977 4.8x12 mm A1A/A2 (dk 8.5 mm)
8. Self drilling screw DIN 7504-K4.8x22 mm A2/50
9. Flat head self-tapping screw 4.2x22 mm A2/50
10. Intermediate vertical stiffener PCI
11. Intermediate horizontal stiffener LC-RH
12. Elastomer
13. SIKATAK PANEL 3 double-sided tape
14. SIKATAK PANEL 50 structural silicone

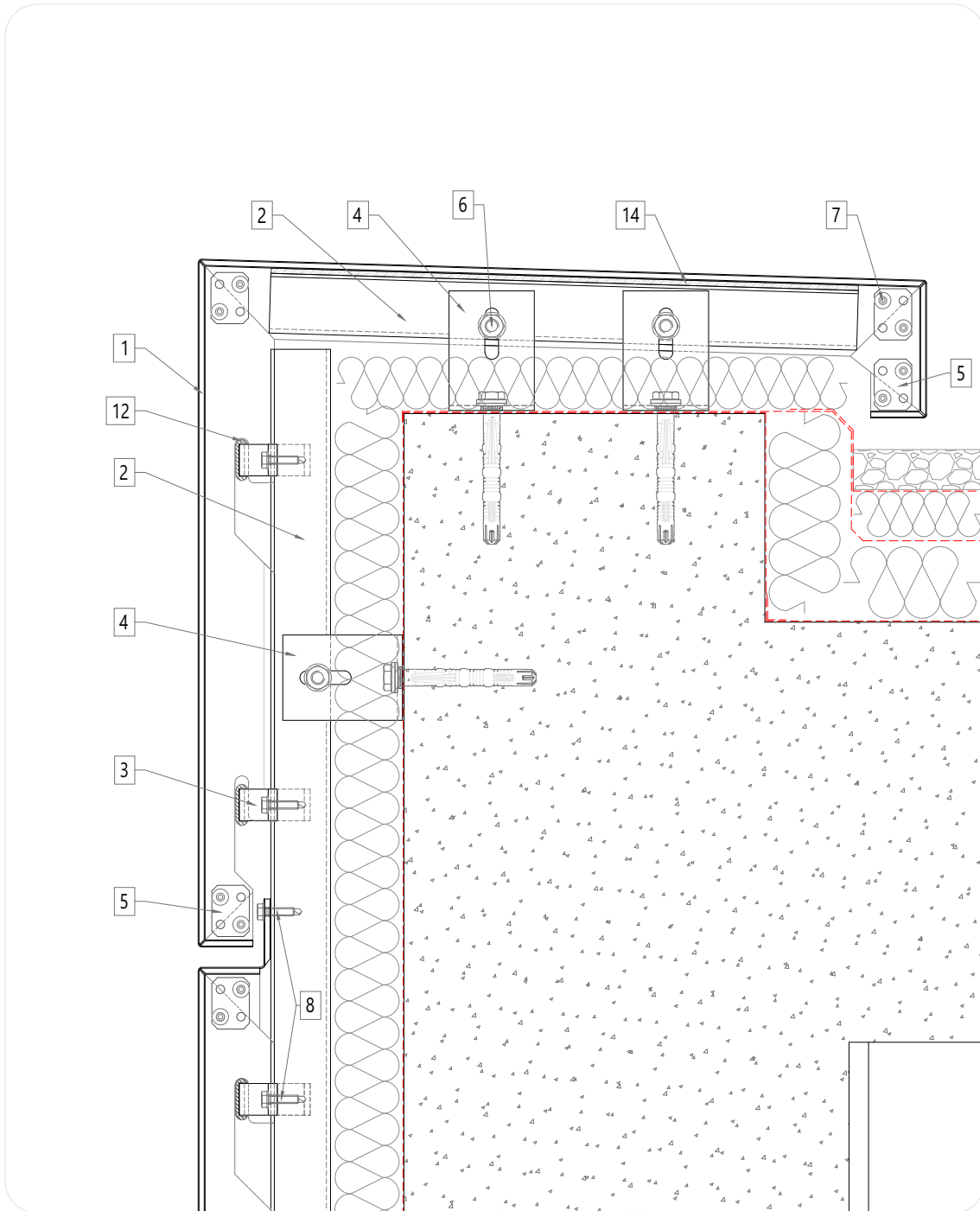

### 07. Parapet detail

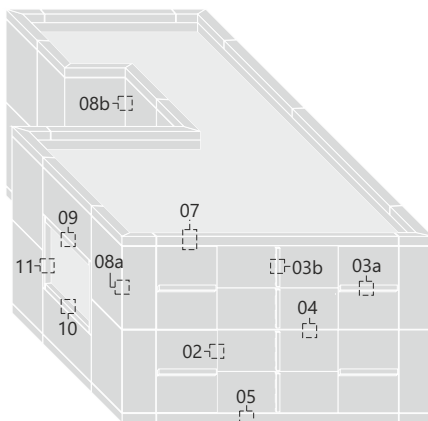

- 1.** larson® composite panel
- 2.** LCH-1 vertical profile
- 3.** LC-3 hanging piece with elastomer
- 4.** LCH-2 bracket
- 5.** 2-3 mm aluminium plate
- 6.** Screw DIN 933 M8x80 mm 8.8  
Washer DIN 125 M8 8.8 (x2)  
Hex nut DIN 934 M8 8.8
- 7.** Blind rivet ISO 18977 4.8x12 mm A1A/A2 (dk 8.5 mm)
- 8.** Self drilling screw DIN 7504-K4.8x22 mm A2/50
- 9.** Flat head self-tapping screw 4.2x22 mm A2/50
- 10.** Intermediate vertical stiffener PCI
- 11.** Intermediate horizontal stiffener LC-RH
- 12.** Elastomer
- 13.** SIKATAACK PANEL 3 double-sided tape
- 14.** SIKATAACK PANEL 50 structural silicone

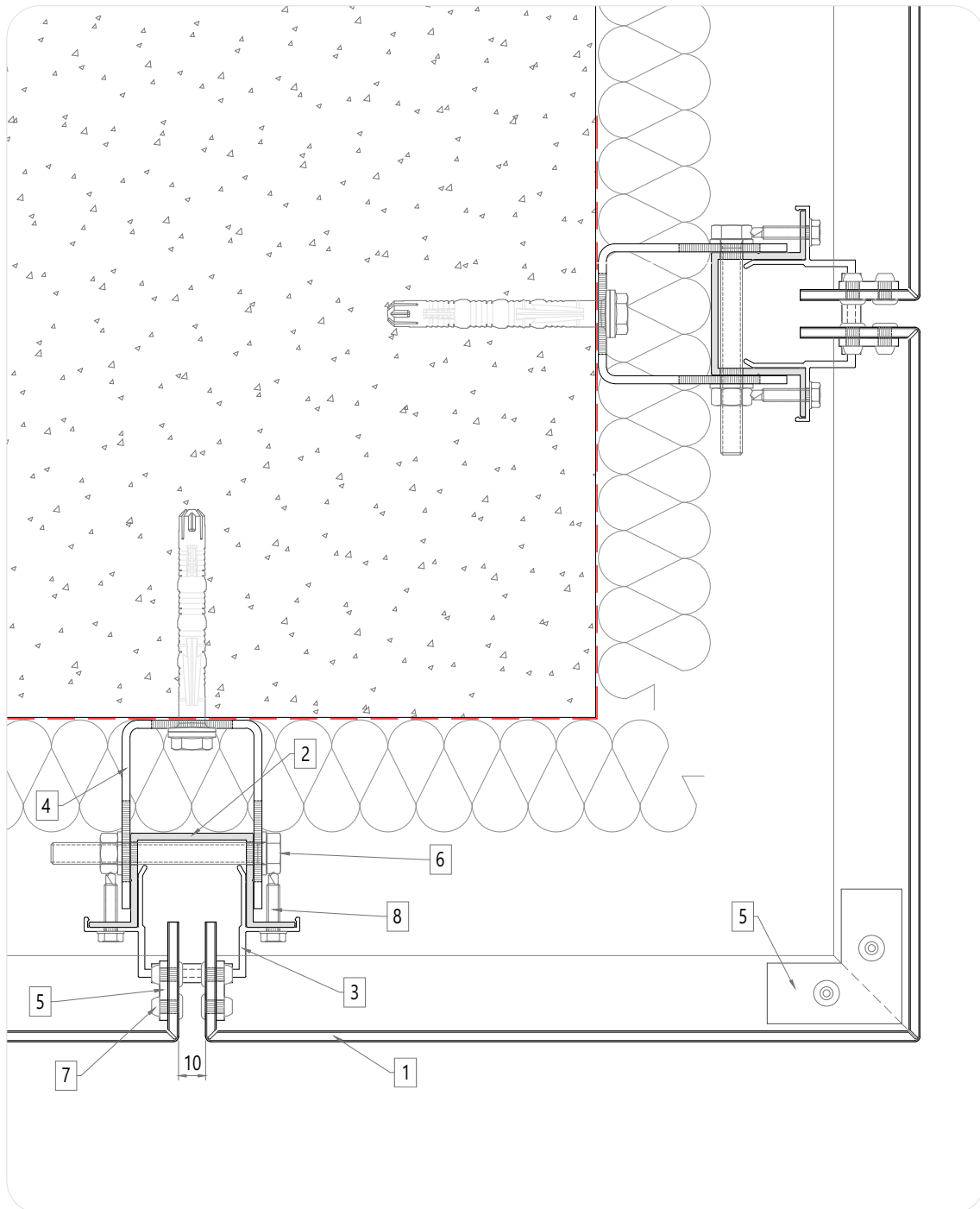

### 08a. External corner

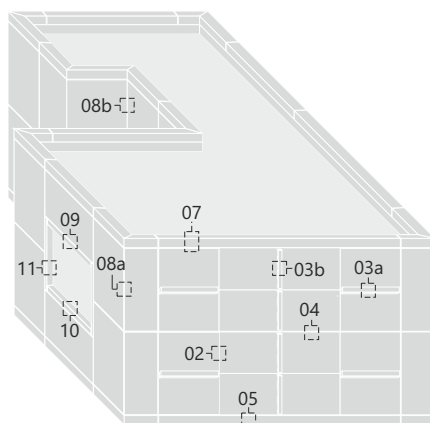

- 1. **larson®** composite panel
- 2. LCH-1 vertical profile
- 3. LC-3 hanging piece with elastomer
- 4. LCH-2 bracket
- 5. 2-3 mm aluminium plate
- 6. Screw DIN 933 M8x80 mm 8.8  
Washer DIN 125 M8 8.8 (x2)  
Hex nut DIN 934 M8 8.8
- 7. Blind rivet ISO 18977 4.8x12 mm A1A/A2 (dk 8.5 mm)
- 8. Self drilling screw DIN 7504-K4.8x22 mm A2/50
- 9. Flat head self-tapping screw 4.2x22 mm A2/50
- 10. Intermediate vertical stiffener PCI
- 11. Intermediate horizontal stiffener LC-RH
- 12. Elastomer
- 13. SIKATAACK PANEL 3 double-sided tape
- 14. SIKATAACK PANEL 50 structural silicone

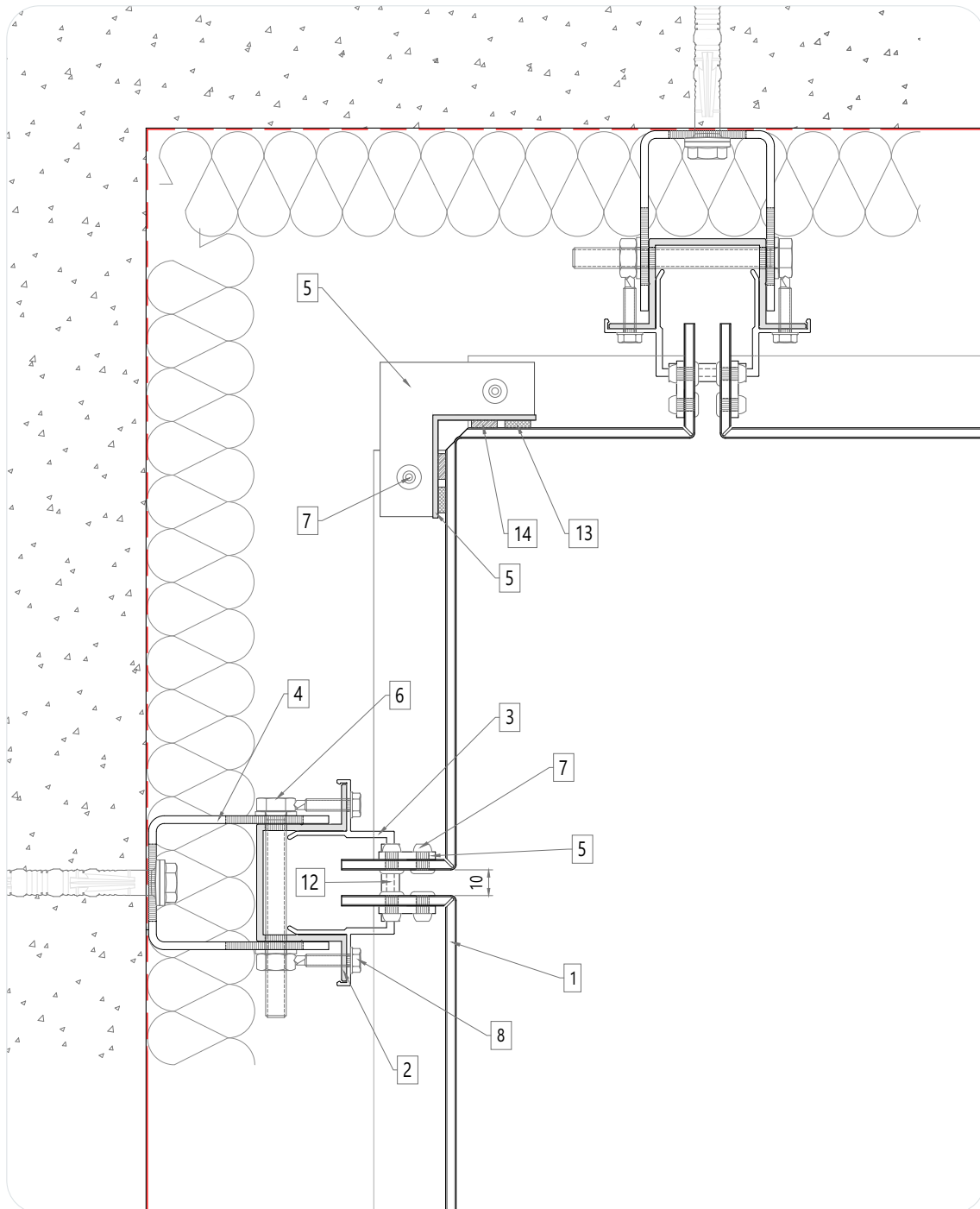

**08b. Internal corner**

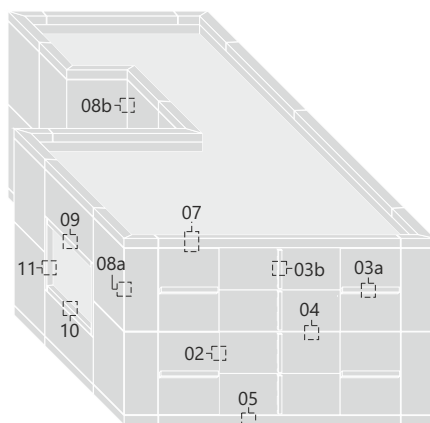

1. **larson®** composite panel
2. LCH-1 vertical profile
3. LC-3 hanging piece with elastomer
4. LCH-2 bracket
5. 2-3 mm aluminium plate
6. Screw DIN 933 M8x80 mm 8.8  
Washer DIN 125 M8 8.8 (x2)  
Hex nut DIN 934 M8 8.8
7. Blind rivet ISO 18977 4.8x12 mm A1A/A2 (dk 8.5 mm)
8. Self drilling screw DIN 7504-K4.8x22 mm A2/50
9. Flat head self-tapping screw 4.2x22 mm A2/50
10. Intermediate vertical stiffener PCI
11. Intermediate horizontal stiffener LC-RH
12. Elastomer
13. SIKATAACK PANEL 3 double-sided tape
14. SIKATAACK PANEL 50 structural silicone

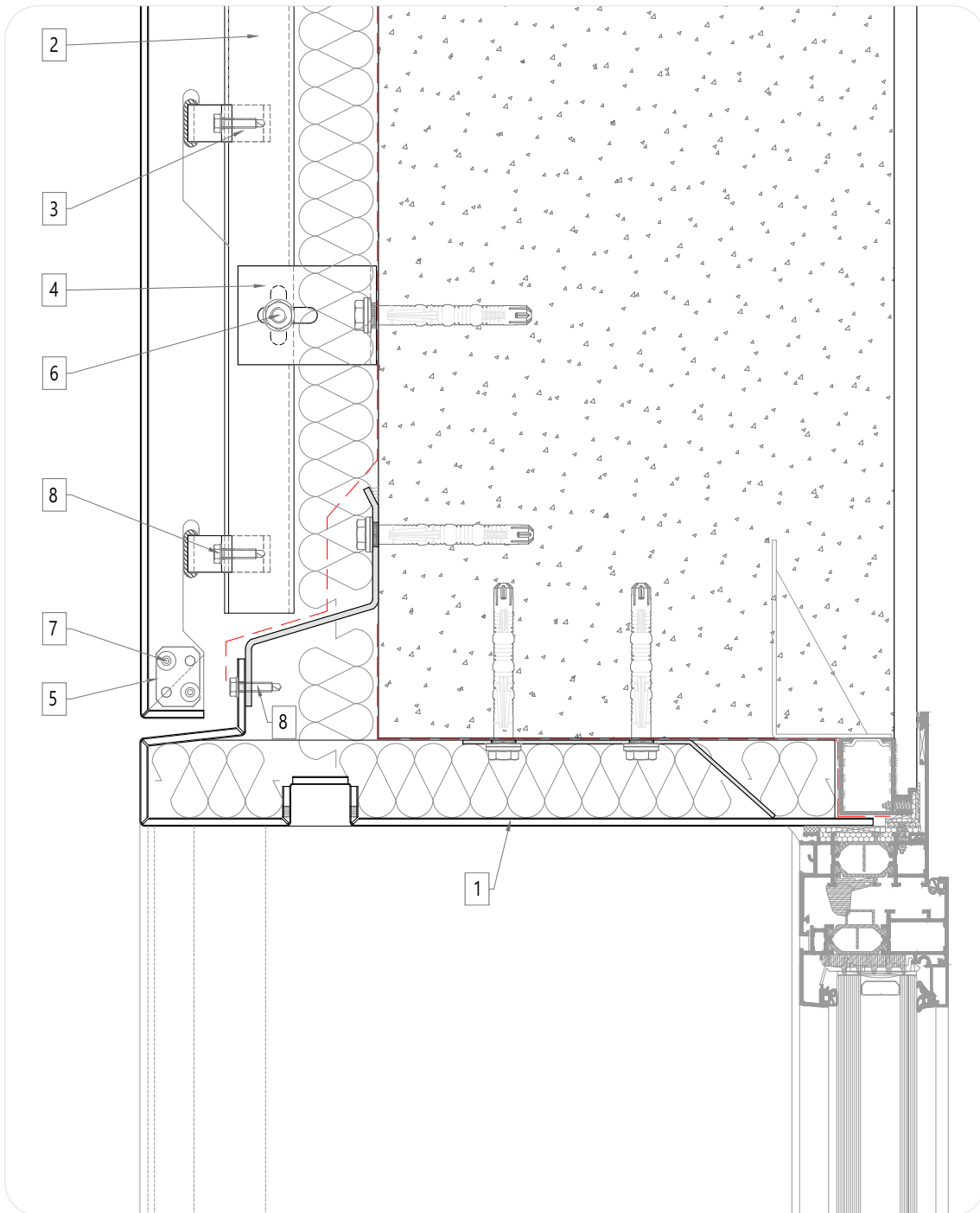

### 09. Window head detail

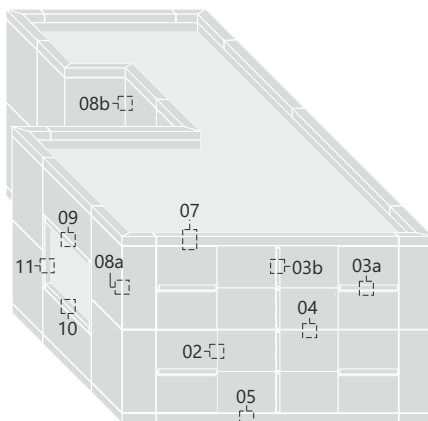

- 1.** larson® composite panel
- 2.** LCH-1 vertical profile
- 3.** LC-3 hanging piece with elastomer
- 4.** LCH-2 bracket
- 5.** 2-3 mm aluminium plate
- 6.** Screw DIN 933 M8x80 mm 8.8  
Washer DIN 125 M8 8.8 (x2)  
Hex nut DIN 934 M8 8.8
- 7.** Blind rivet ISO 18977 4.8x12 mm A1A/A2 (dk 8.5 mm)
- 8.** Self drilling screw DIN 7504-K4.8x22 mm A2/50
- 9.** Flat head self-tapping screw 4.2x22 mm A2/50
- 10.** Intermediate vertical stiffener PCI
- 11.** Intermediate horizontal stiffener LC-RH
- 12.** Elastomer
- 13.** SIKATAACK PANEL 3 double-sided tape
- 14.** SIKATAACK PANEL 50 structural silicone



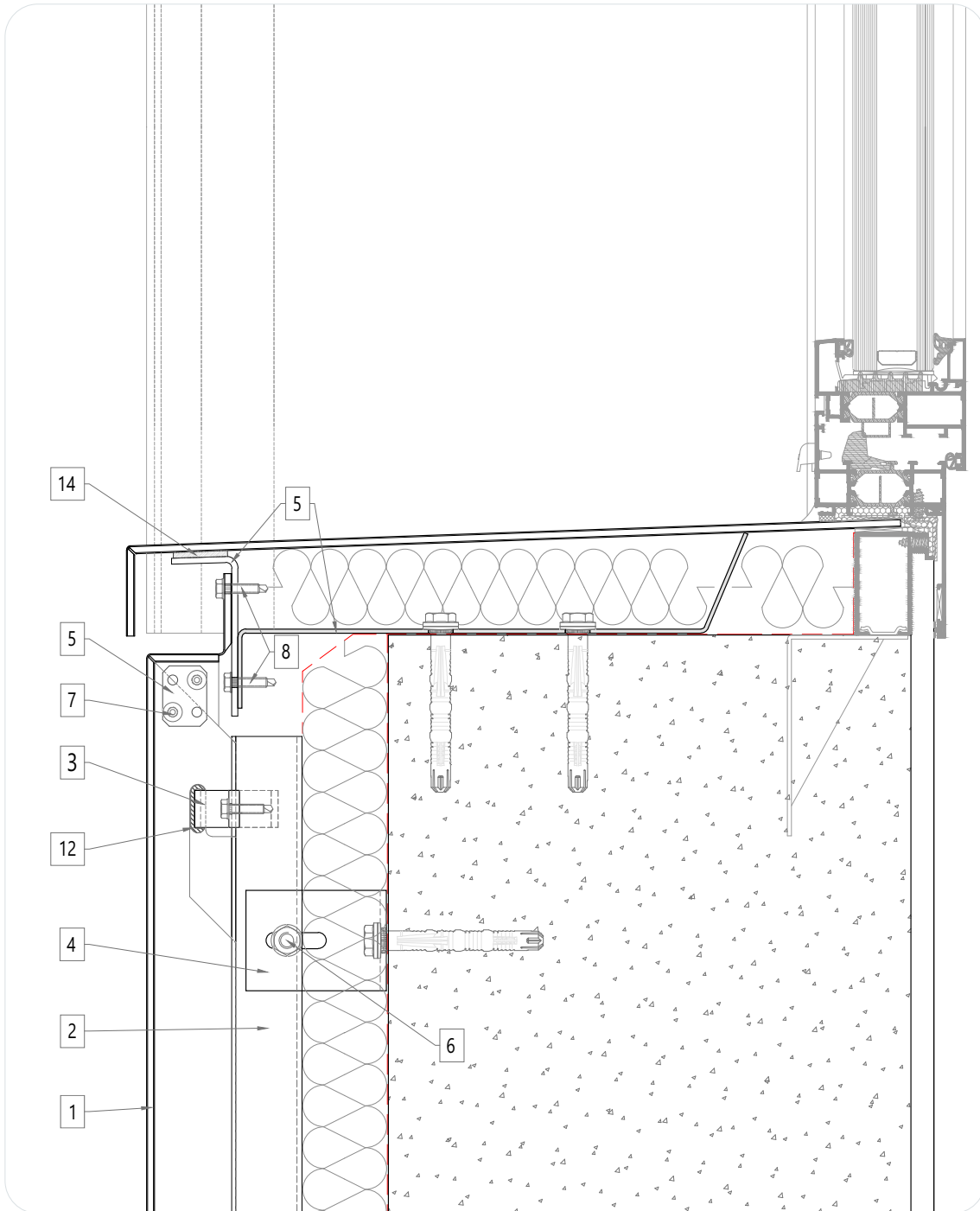

**10. Window sill detail**

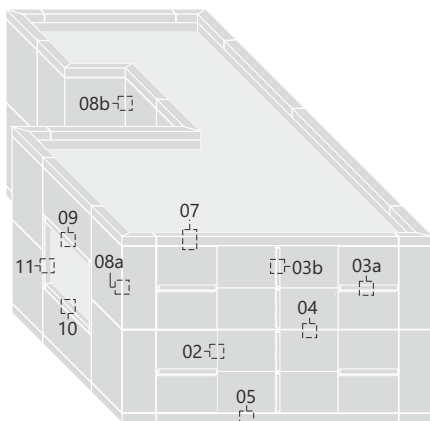

- 1.** larson® composite panel
- 2.** LCH-1 vertical profile
- 3.** LC-3 hanging piece with elastomer
- 4.** LCH-2 bracket
- 5.** 2-3 mm aluminium plate
- 6.** Screw DIN 933 M8x80 mm 8.8  
Washer DIN 125 M8 8.8 (x2)  
Hex nut DIN 934 M8 8.8
- 7.** Blind rivet ISO 18977 4.8x12 mm A1A/A2 (dk 8.5 mm)
- 8.** Self drilling screw DIN 7504-K4.8x22 mm A2/50
- 9.** Flat head self-tapping screw 4.2x22 mm A2/50
- 10.** Intermediate vertical stiffener PCI
- 11.** Intermediate horizontal stiffener LC-RH
- 12.** Elastomer
- 13.** SIKATAK PANEL 3 double-sided tape
- 14.** SIKATAK PANEL 50 structural silicone

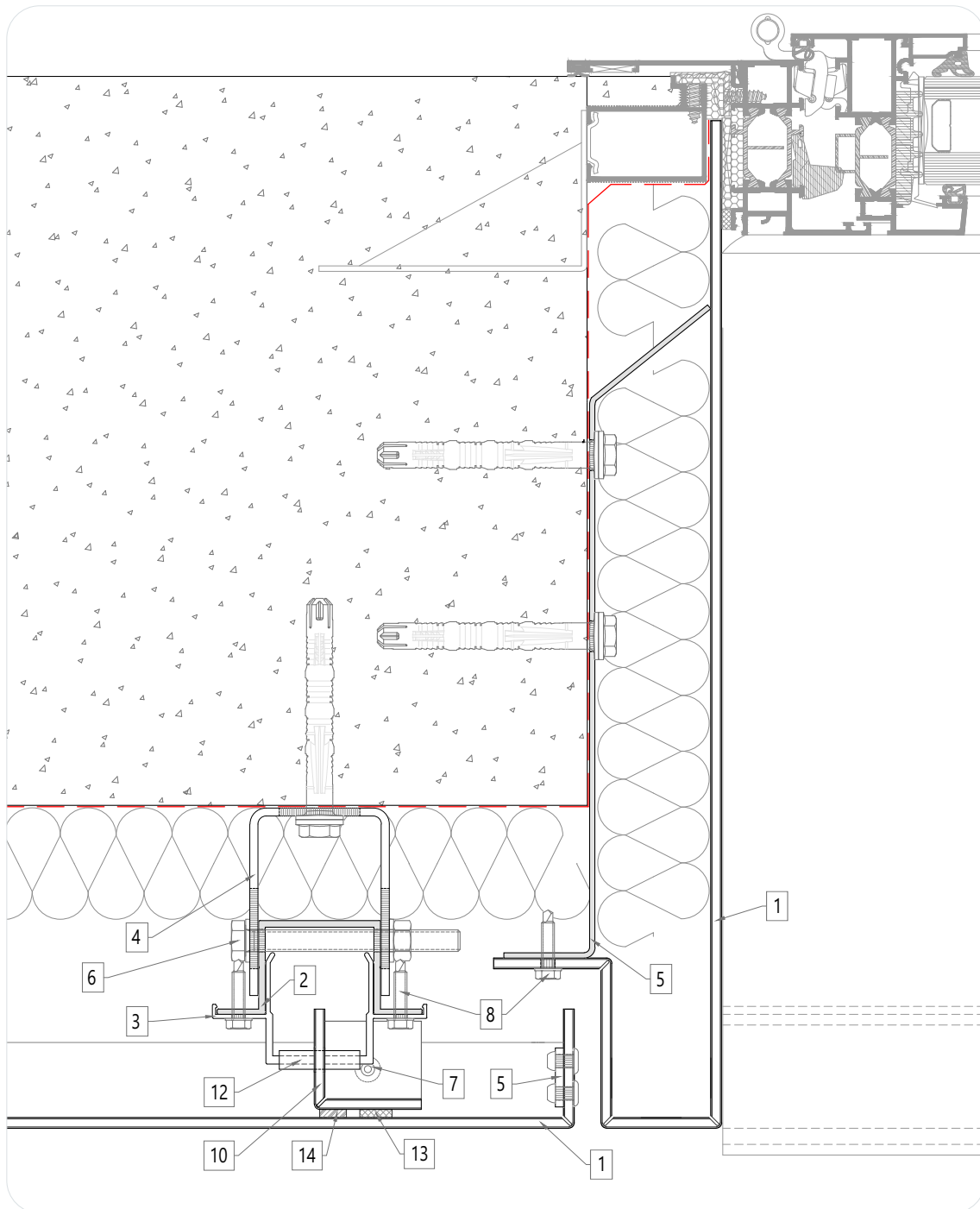

### 11. Window jamb detail

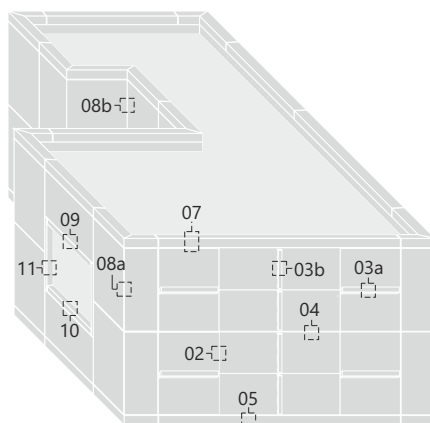

- 1. **larson®** composite panel
- 2. LCH-1 vertical profile
- 3. LC-3 hanging piece with elastomer
- 4. LCH-2 bracket
- 5. 2-3 mm aluminium plate
- 6. Screw DIN 933 M8x80 mm 8.8  
Washer DIN 125 M8 8.8 (x2)  
Hex nut DIN 934 M8 8.8
- 7. Blind rivet ISO 18977 4.8x12 mm A1A/A2 (dk 8.5 mm)
- 8. Self drilling screw DIN 7504-K4.8x22 mm A2/50
- 9. Flat head self-tapping screw 4.2x22 mm A2/50
- 10. Intermediate vertical stiffener PCI
- 11. Intermediate horizontal stiffener LC-RH
- 12. Elastomer
- 13. SIKATAK PANEL 3 double-sided tape
- 14. SIKATAK PANEL 50 structural silicone



LCH-1 system "**larson**<sup>®</sup> cassettes"  
MOCK UP - Render drawn by SolidWorks

# larson<sup>®</sup>





## LC4-LC6 system "larson® cassette"

### 01. Outside elevation

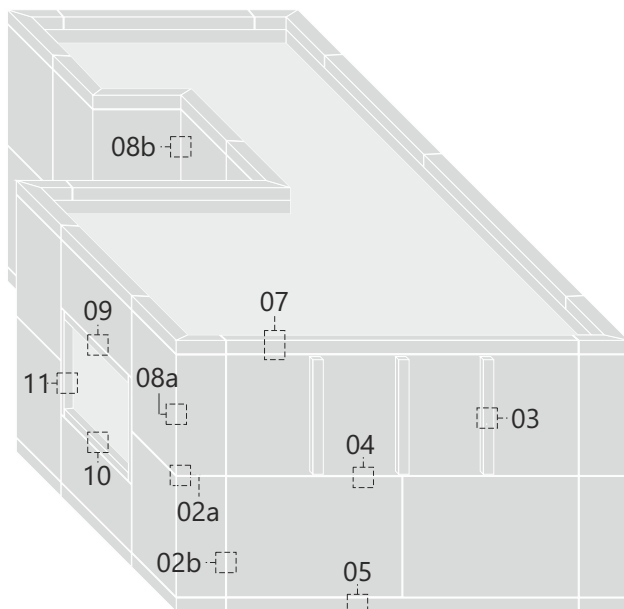
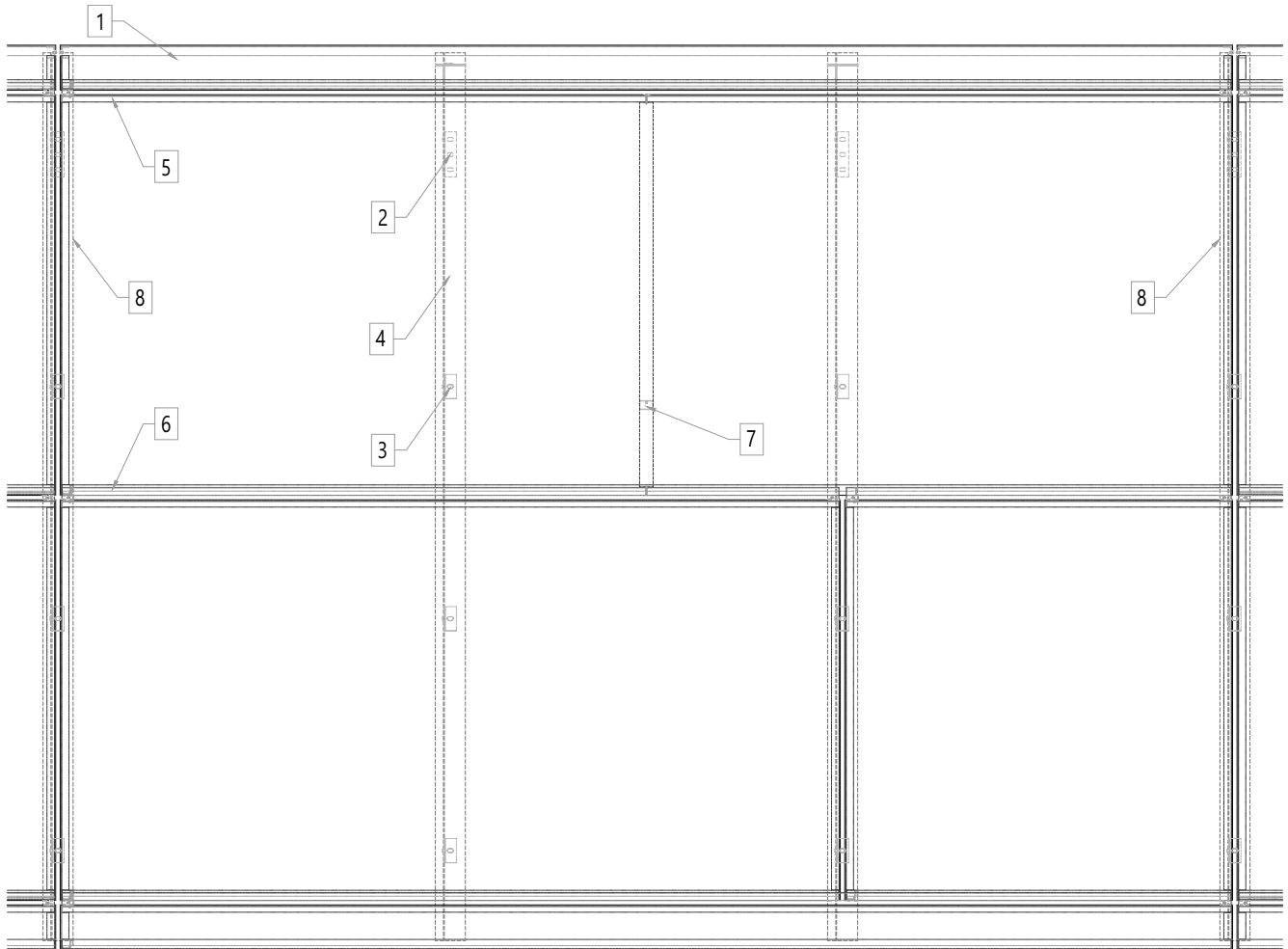

- 1. **larson®** composite panel
- 2. LT-1A wind-weight bracket
- 3. LT-1B wind bracket
- 4. LT-2 vertical profile
- 5. LC-4 profile
- 6. LC-6 profile
- 7. LC-RH intermediate vertical stiffener
- 8. LC-RC vertical edges stiffener
- 9. ISO 115977 4.8x10mm A1A/A2 (dk 9.5 mm) bind rivet
- 10. ISO 115977 4.8x12mm A1A/A2 (dk 9.5 mm) bild rivet
- 11. Antivibration clip
- 12. EJOT® Inox SAPHIR self drilling screw
- 13. INDEX DIN7981 HP 4.2x50 mm A2 pan-head screw
- 14. SIKATAK PANEL 50 adhesive
- 15. 2-3 mm aluminium plate
- 16. LT-0A/B thermal break

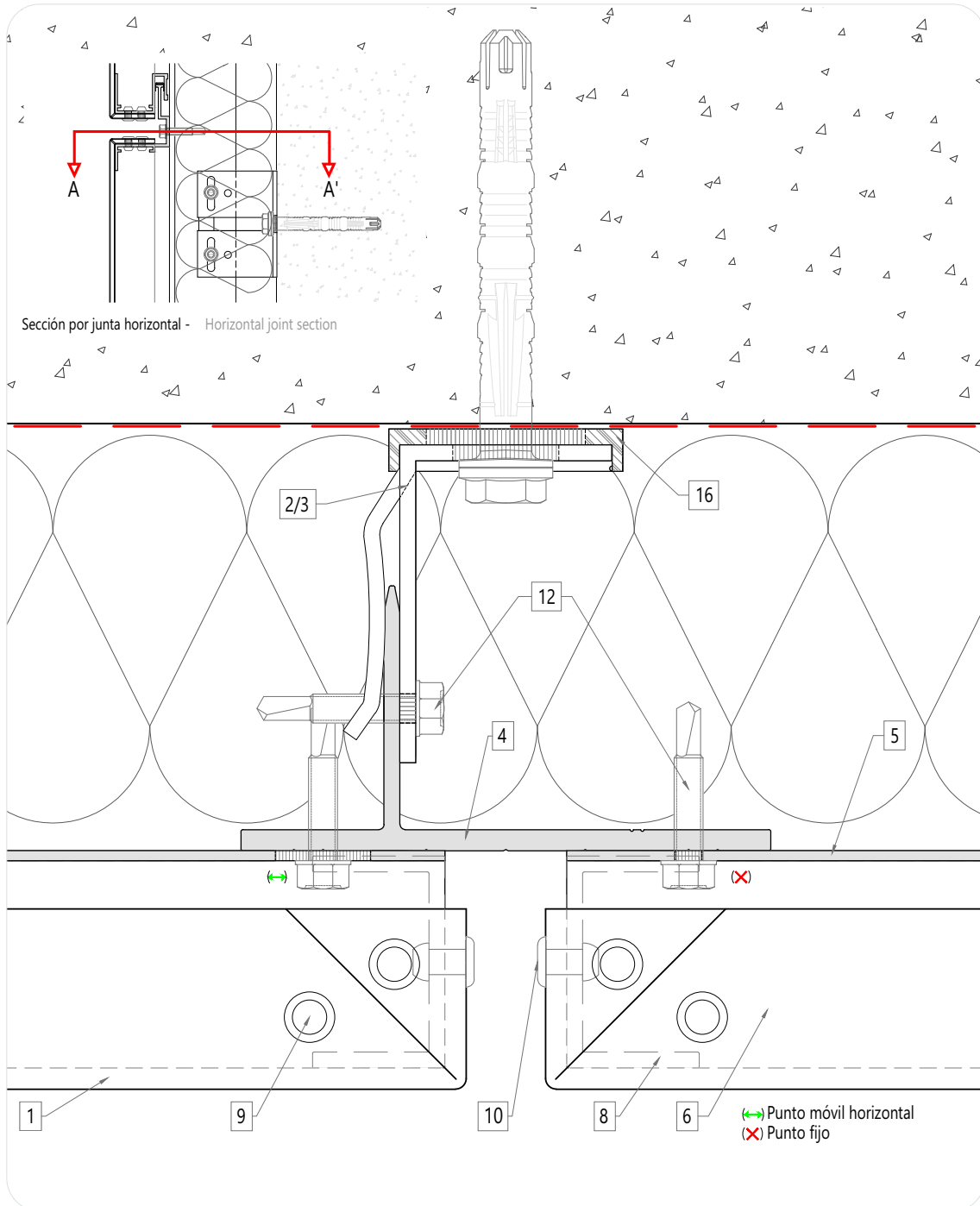

## 02. Vertical joint

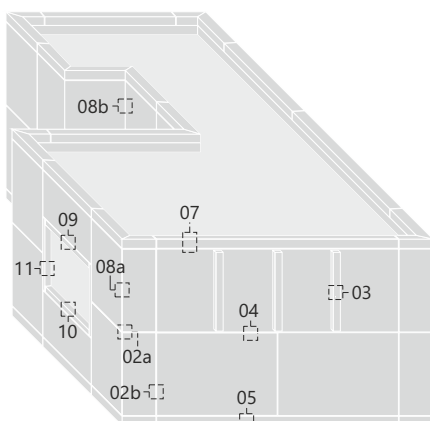

1. **larson®** composite panel
2. LT-1A wind-weight bracket
3. LT-1B wind bracket
4. LT-2 vertical profile
5. LC-4 profile
6. LC-6 profile
7. LC-RH intermediate vertical stiffener
8. LC-RC vertical edges stiffener
9. ISO 115977 4.8x10mm A1A/A2 (dk 9.5 mm) bind rivet
10. ISO 115977 4.8x12mm A1A/A2 (dk 9.5 mm) bild rivet
11. Antivibration clip
12. EJOT® Inox SAPHIR self drilling screw
13. INDEX DIN7981 HP 4.2x50 mm A2 pan-head screw
14. SIKATAACK PANEL 50 adhesive
15. 2-3 mm aluminium plate
16. LT-0A/B thermal break

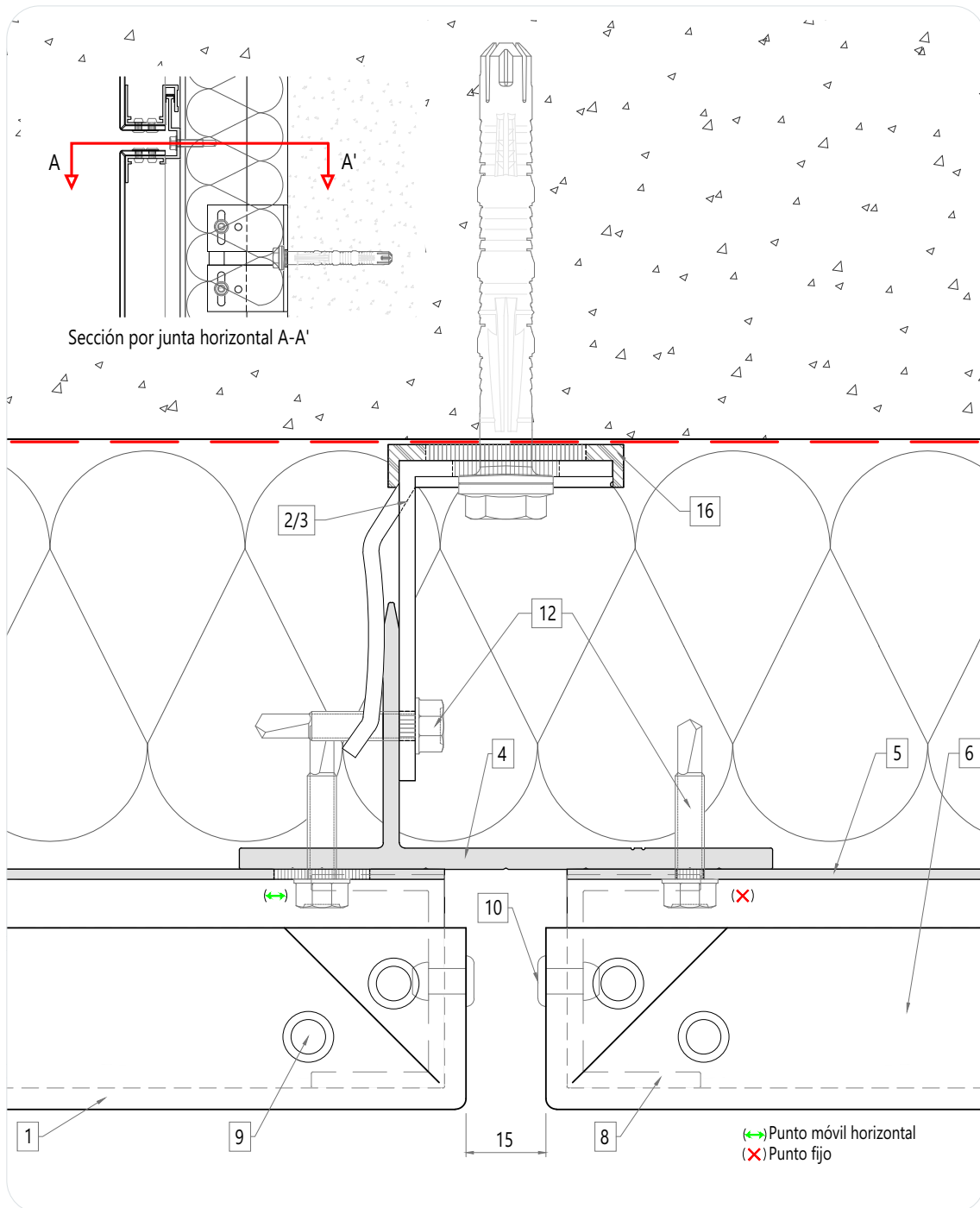

**02a. Vertical joint A-A'**

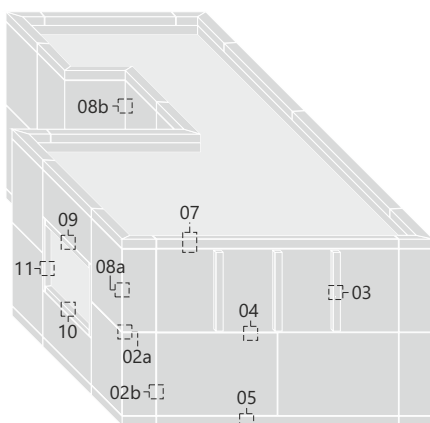

1. larson® composite panel
2. LT-1A wind-weight bracket
3. LT-1B wind bracket
4. LT-2 vertical profile
5. LC-4 profile
6. LC-6 profile
7. LC-RH intermediate vertical stiffener
8. LC-RC vertical edges stiffener
9. ISO 115977 4.8x10mm A1A/A2 (dk 9.5 mm) bind rivet
10. ISO 115977 4.8x12mm A1A/A2 (dk 9.5 mm) bild rivet
11. Antivibration clip
12. EJOT® Inox SAPHIR self drilling screw
13. INDEX DIN7981 HP 4.2x50 mm A2 pan-head screw
14. SIKATAACK PANEL 50 adhesive
15. 2-3 mm aluminium plate
16. LT-0A/B thermal break

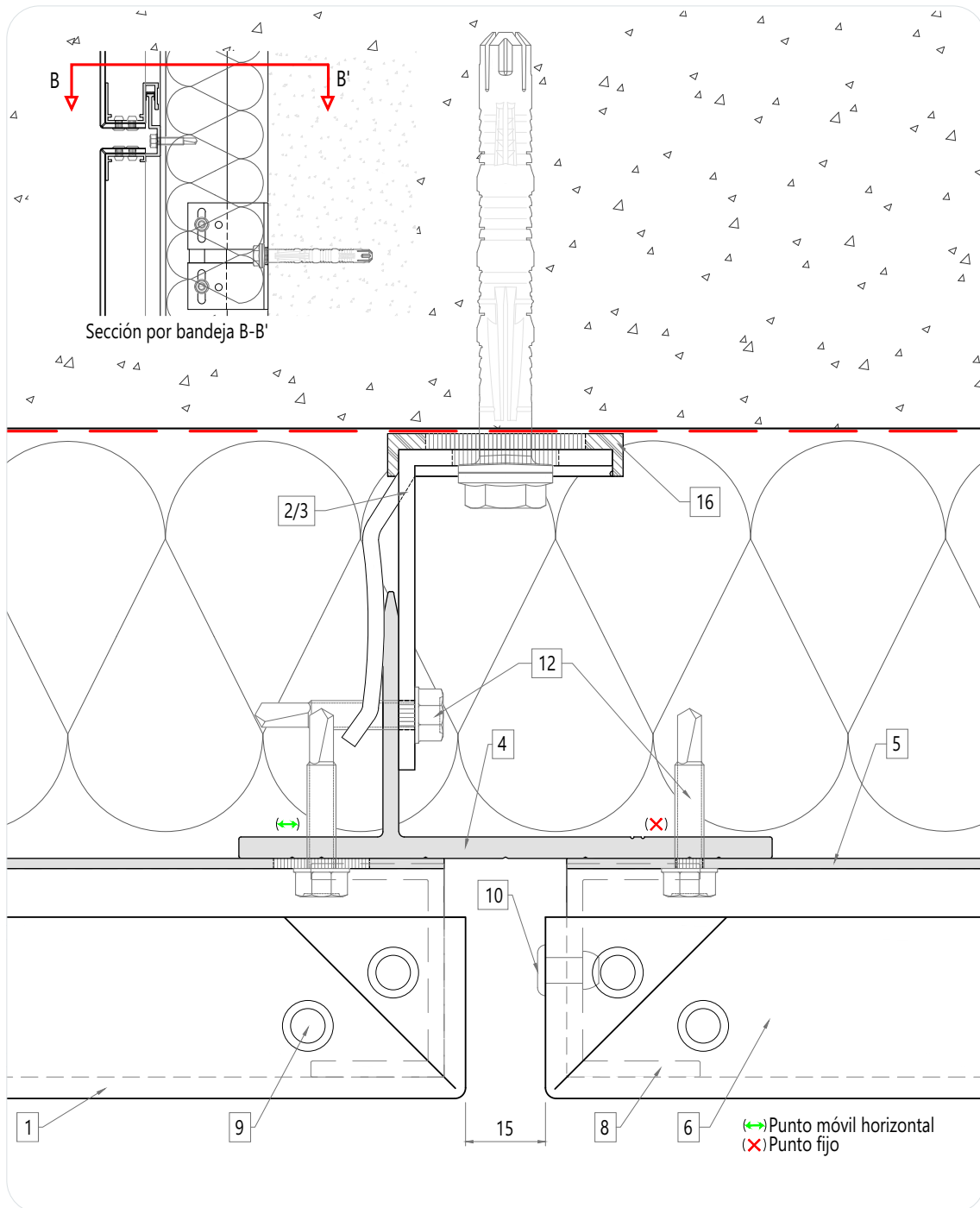

### 02b. Vertical joint B-B'

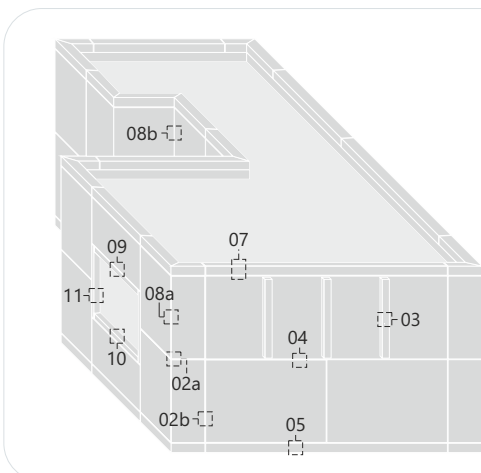

- 1. larson® composite panel
- 2. LT-1A wind-weight bracket
- 3. LT-1B wind bracket
- 4. LT-2 vertical profile
- 5. LC-4 profile
- 6. LC-6 profile
- 7. LC-RH intermediate vertical stiffener
- 8. LC-RC vertical edges stiffener
- 9. ISO 115977 4.8x10mm A1A/A2 (dk 9.5 mm) bind rivet
- 10. ISO 115977 4.8x12mm A1A/A2 (dk 9.5 mm) bild rivet
- 11. Antivibration clip
- 12. EJOT® Inox SAPHIR self drilling screw
- 13. INDEX DIN7981 HP 4.2x50 mm A2 pan-head screw
- 14. SIKATAACK PANEL 50 adhesive
- 15. 2-3 mm aluminium plate
- 16. LT-0A/B thermal break

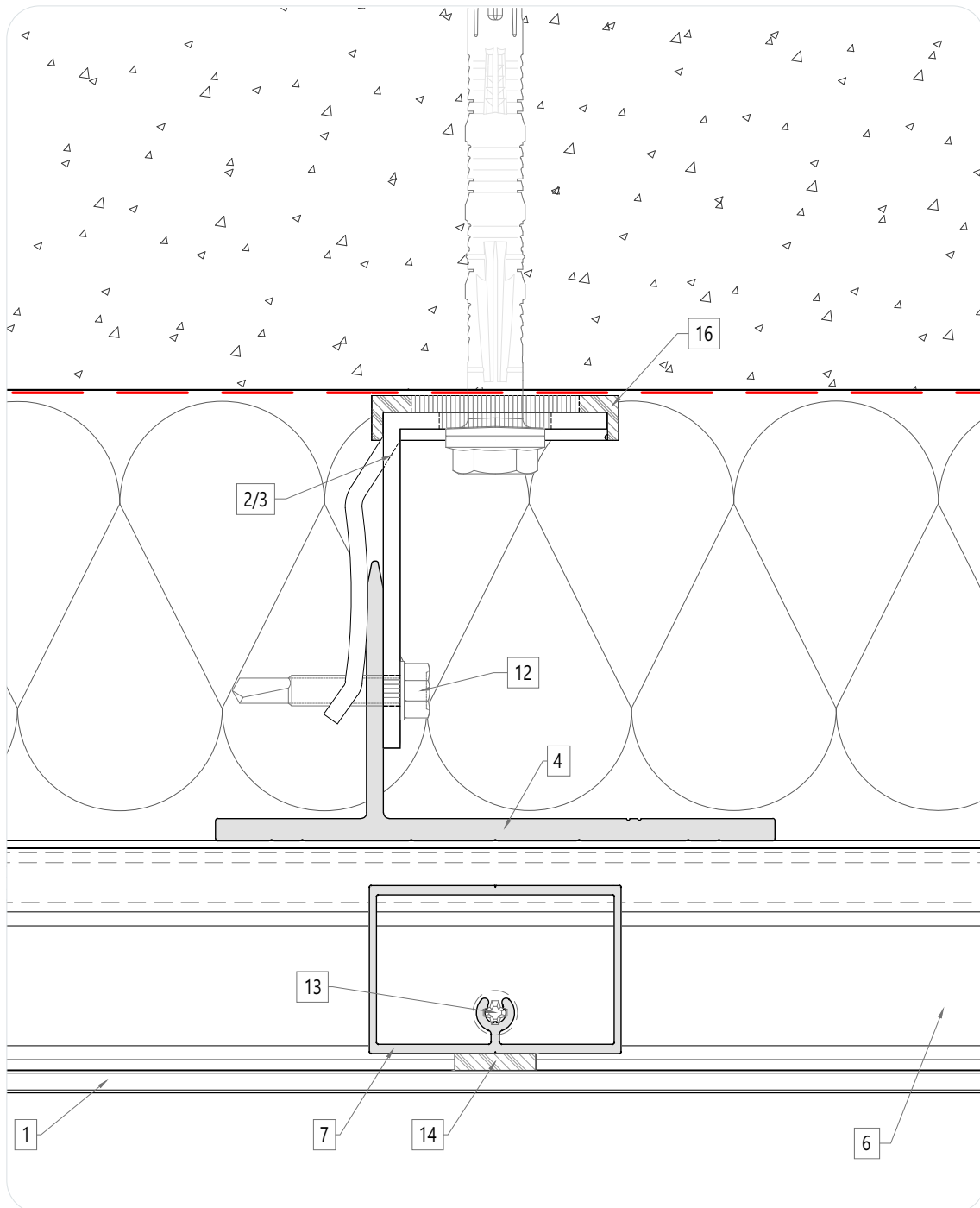

### 03a. Intermediate stiffener. Horizontal section

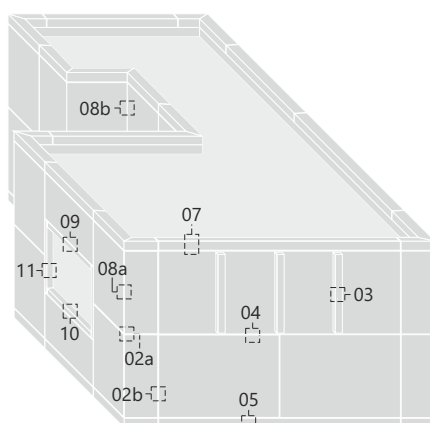

1. **larson®** composite panel
2. LT-1A wind-weight bracket
3. LT-1B wind bracket
4. LT-2 vertical profile
5. LC-4 profile
6. LC-6 profile
7. LC-RH intermediate vertical stiffener
8. LC-RC vertical edges stiffener
9. ISO 115977 4.8x10mm A1A/A2 (dk 9.5 mm) bind rivet
10. ISO 115977 4.8x12mm A1A/A2 (dk 9.5 mm) bild rivet
11. Antivibration clip
12. EJOT® Inox SAPHIR self drilling screw
13. INDEX DIN7981 HP 4.2x50 mm A2 pan-head screw
14. SIKATAACK PANEL 50 adhesive
15. 2-3 mm aluminium plate
16. LT-0A/B thermal break



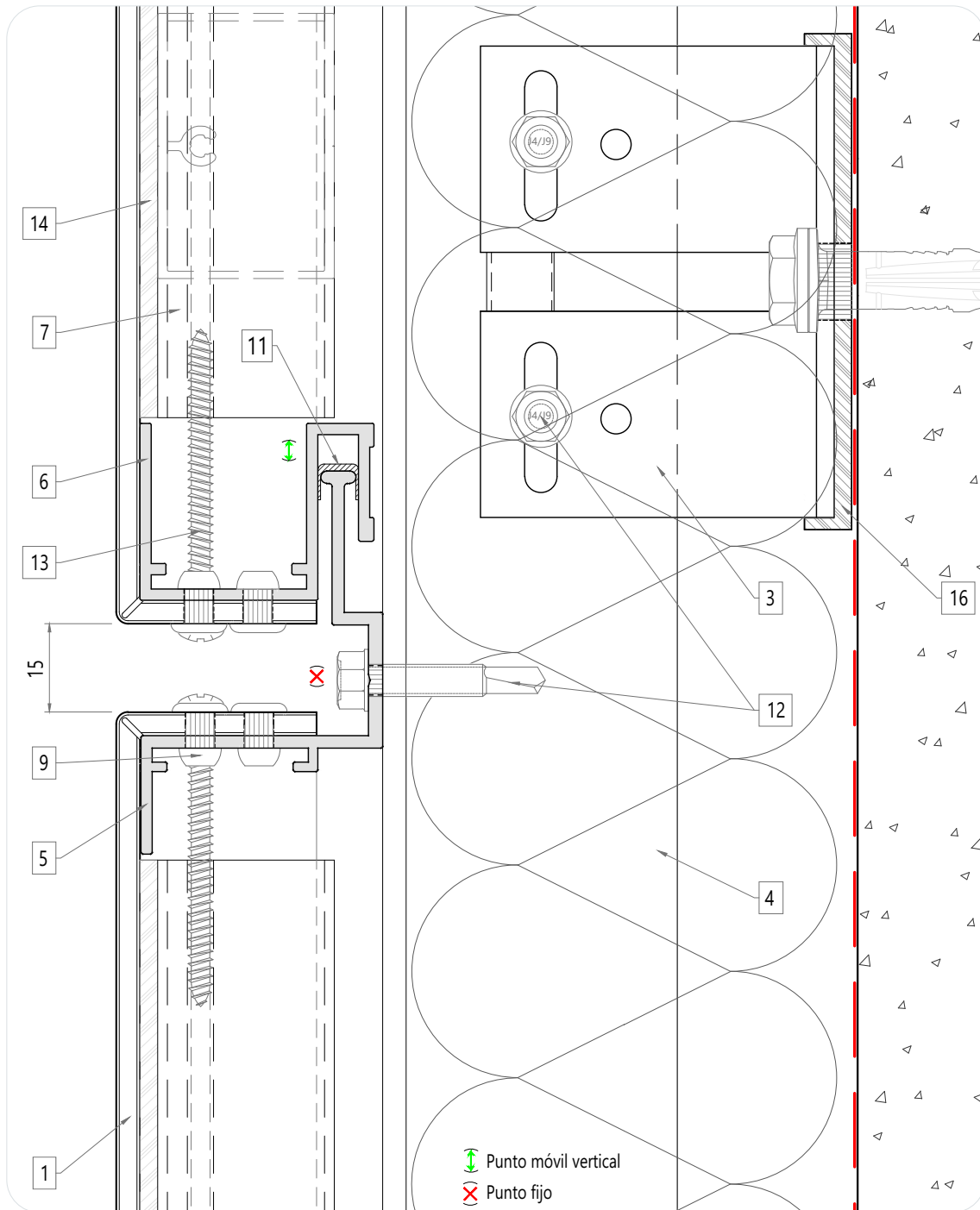

**03b. Vertical stiffener. Vertical section**

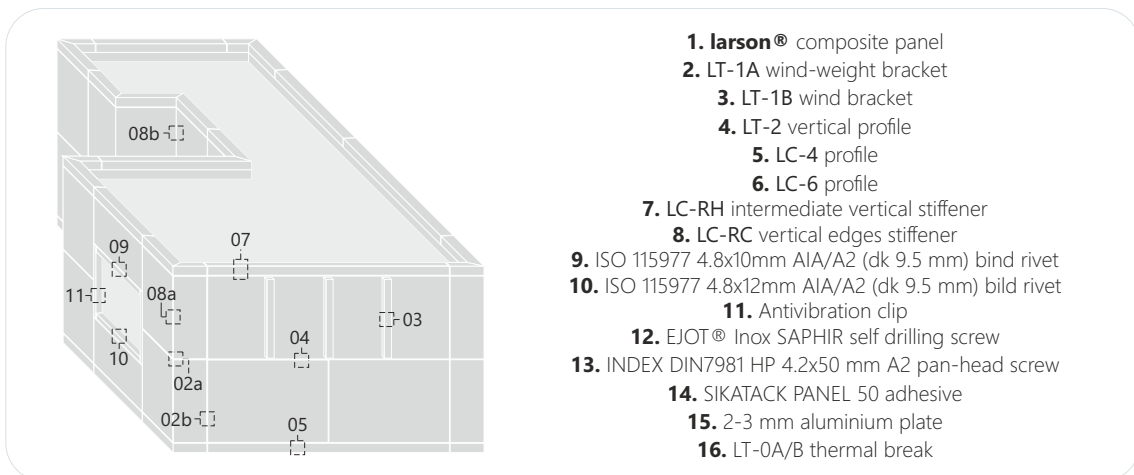

- 1. larson® composite panel
- 2. LT-1A wind-weight bracket
- 3. LT-1B wind bracket
- 4. LT-2 vertical profile
- 5. LC-4 profile
- 6. LC-6 profile
- 7. LC-RH intermediate vertical stiffener
- 8. LC-RC vertical edges stiffener
- 9. ISO 115977 4.8x10mm A1A/A2 (dk 9.5 mm) bind rivet
- 10. ISO 115977 4.8x12mm A1A/A2 (dk 9.5 mm) bild rivet
- 11. Antivibration clip
- 12. EJOT® Inox SAPHIR self drilling screw
- 13. INDEX DIN7981 HP 4.2x50 mm A2 pan-head screw
- 14. SIKATAACK PANEL 50 adhesive
- 15. 2-3 mm aluminium plate
- 16. LT-0A/B thermal break

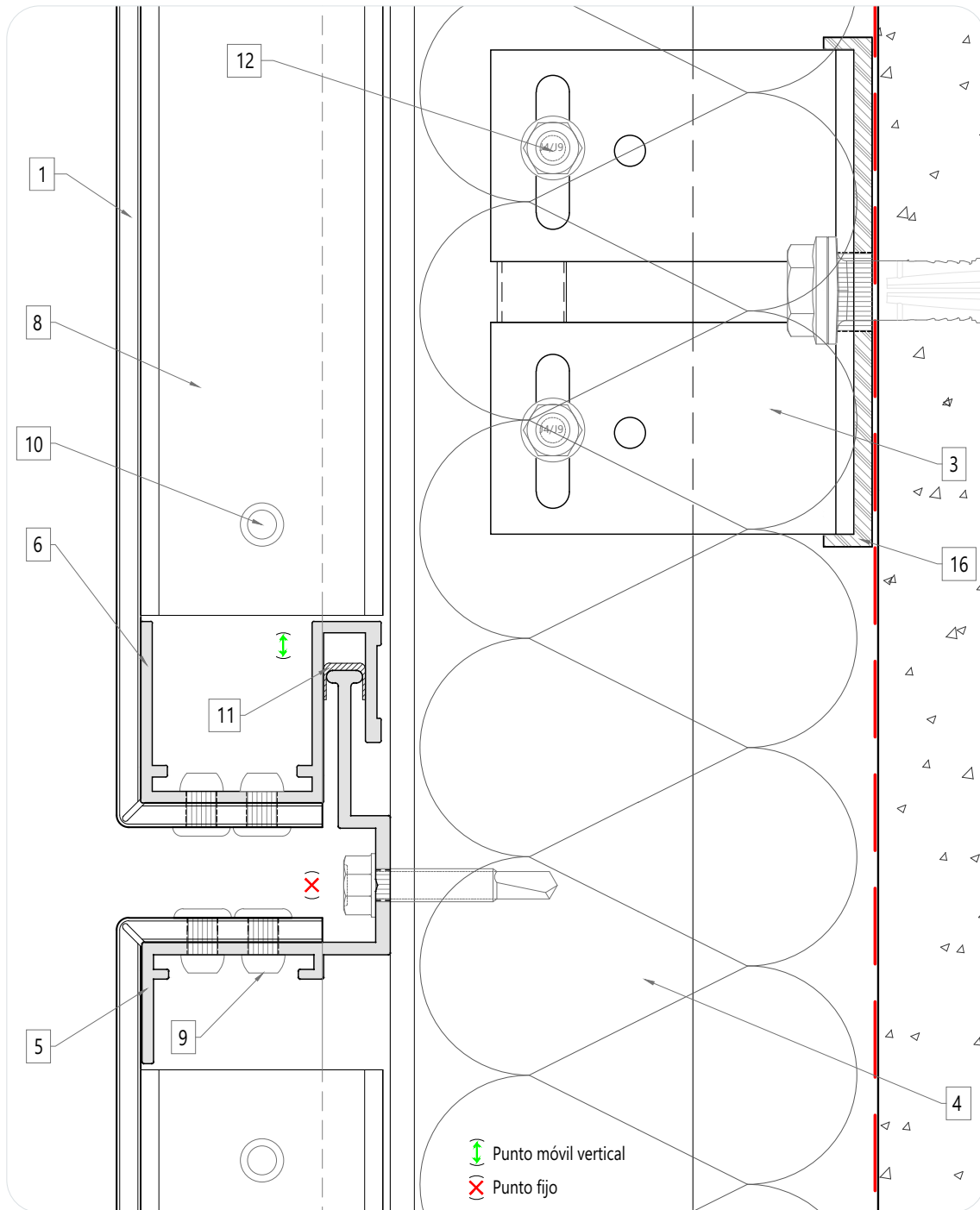

#### 04. Horizontal joint

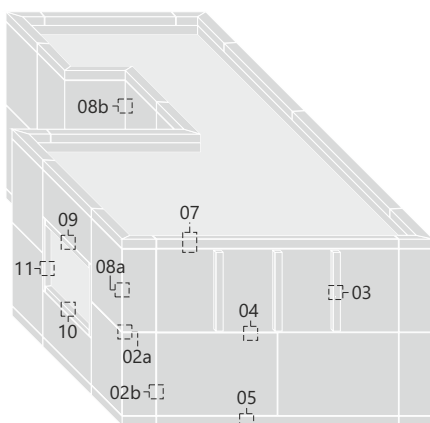

1. larson® composite panel
2. LT-1A wind-weight bracket
3. LT-1B wind bracket
4. LT-2 vertical profile
5. LC-4 profile
6. LC-6 profile
7. LC-RH intermediate vertical stiffener
8. LC-RC vertical edges stiffener
9. ISO 115977 4.8x10mm A1A/A2 (dk 9.5 mm) bind rivet
10. ISO 115977 4.8x12mm A1A/A2 (dk 9.5 mm) bild rivet
11. Antivibration clip
12. EJOT® Inox SAPHIR self drilling screw
13. INDEX DIN7981 HP 4.2x50 mm A2 pan-head screw
14. SIKATAACK PANEL 50 adhesive
15. 2-3 mm aluminium plate
16. LT-0A/B thermal break

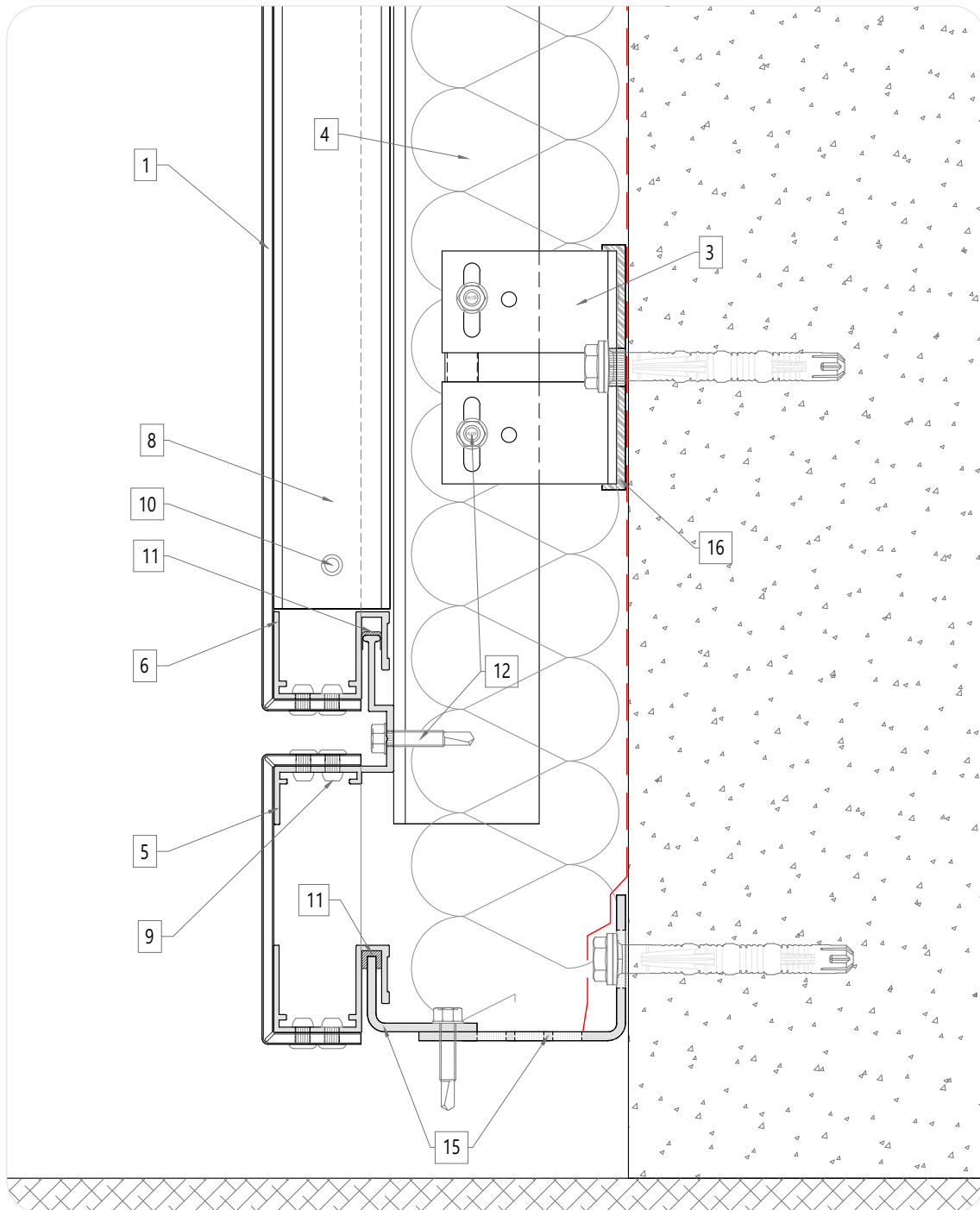

## 05. Façade starting

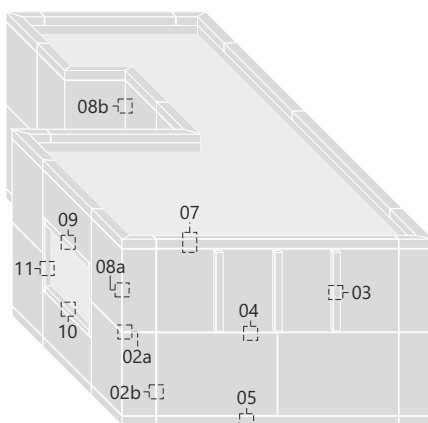

1. **larson®** composite panel
2. LT-1A wind-weight bracket
3. LT-1B wind bracket
4. LT-2 vertical profile
5. LC-4 profile
6. LC-6 profile
7. LC-RH intermediate vertical stiffener
8. LC-RC vertical edges stiffener
9. ISO 115977 4.8x10mm A1A/A2 (dk 9.5 mm) bind rivet
10. ISO 115977 4.8x12mm A1A/A2 (dk 9.5 mm) bild rivet
11. Antivibration clip
12. EJOT® Inox SAPHIR self drilling screw
13. INDEX DIN7981 HP 4.2x50 mm A2 pan-head screw
14. SIKATAACK PANEL 50 adhesive
15. 2-3 mm aluminium plate
16. LT-0A/B thermal break

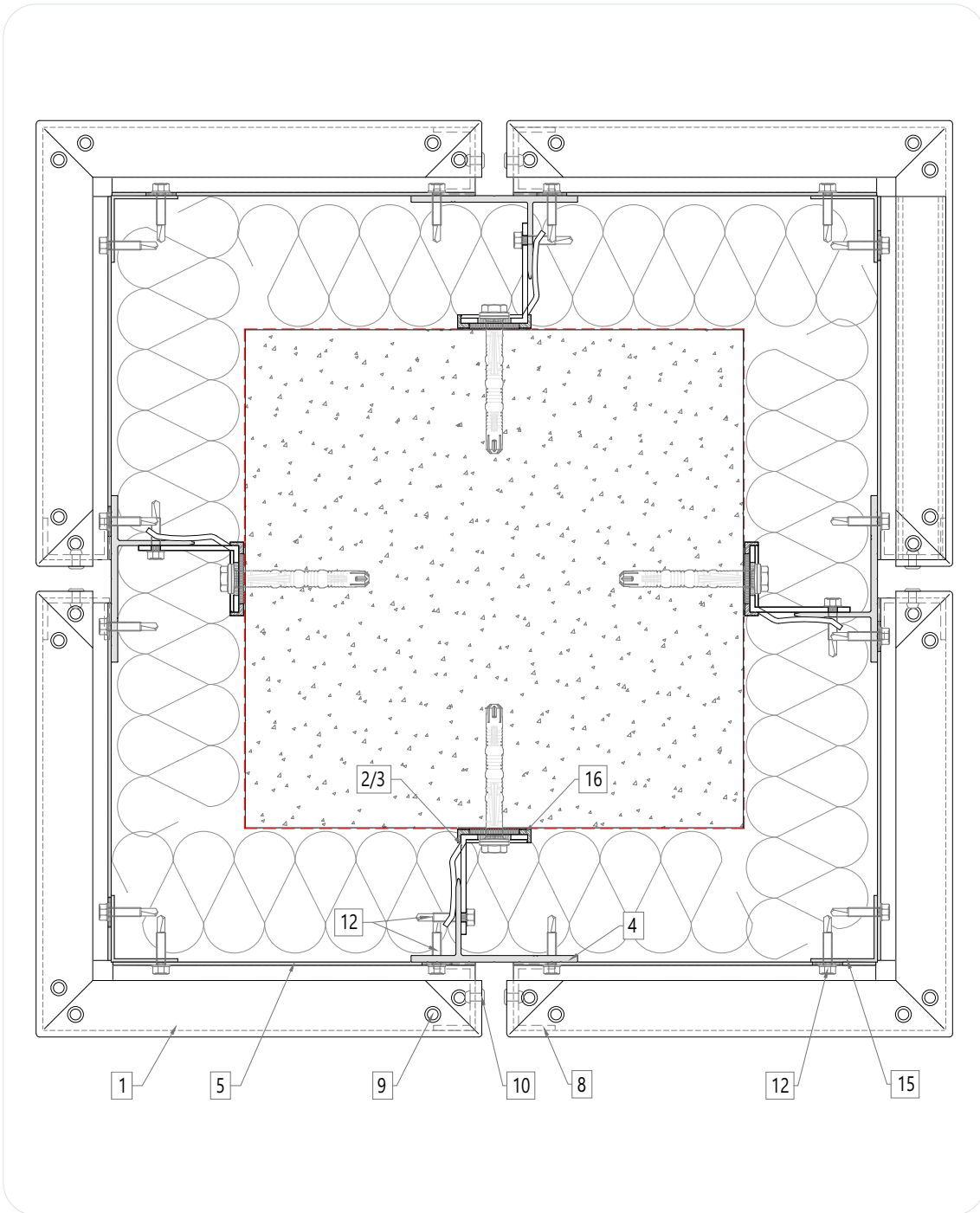

## 06. Columns

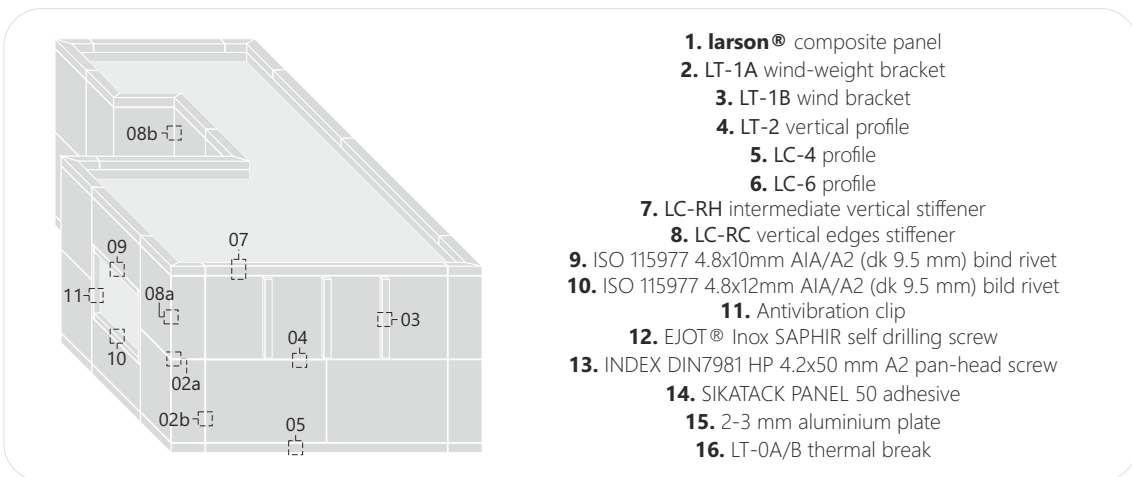

1. **larson®** composite panel
2. LT-1A wind-weight bracket
3. LT-1B wind bracket
4. LT-2 vertical profile
5. LC-4 profile
6. LC-6 profile
7. LC-RH intermediate vertical stiffener
8. LC-RC vertical edges stiffener
9. ISO 115977 4.8x10mm A1A/A2 (dk 9.5 mm) bind rivet
10. ISO 115977 4.8x12mm A1A/A2 (dk 9.5 mm) bild rivet
11. Antivibration clip
12. EJOT® Inox SAPHIR self drilling screw
13. INDEX DIN7981 HP 4.2x50 mm A2 pan-head screw
14. SIKATAACK PANEL 50 adhesive
15. 2-3 mm aluminium plate
16. LT-0A/B thermal break

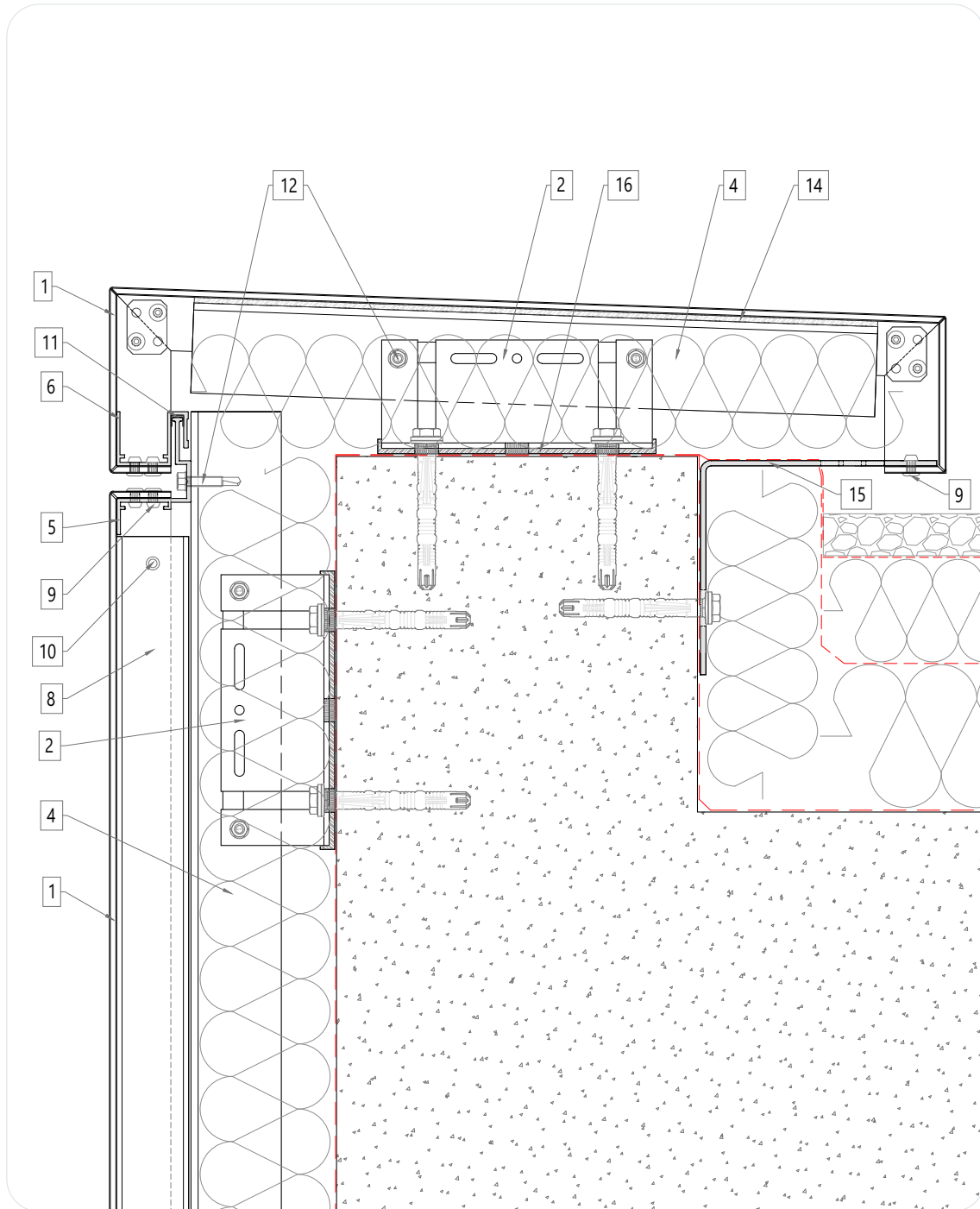

### 07. Parapet detail

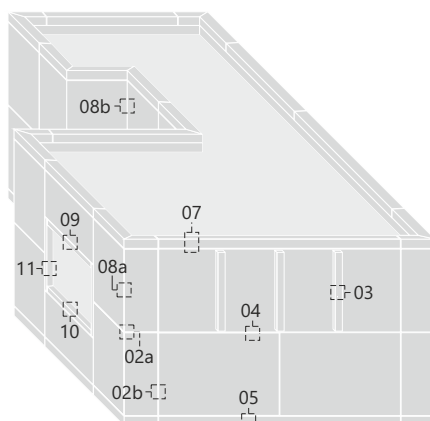

- 1. **larson®** composite panel
- 2. LT-1A wind-weight bracket
- 3. LT-1B wind bracket
- 4. LT-2 vertical profile
- 5. LC-4 profile
- 6. LC-6 profile
- 7. LC-RH intermediate vertical stiffener
- 8. LC-RC vertical edges stiffener
- 9. ISO 115977 4.8x10mm A1A/A2 (dk 9.5 mm) bind rivet
- 10. ISO 115977 4.8x12mm A1A/A2 (dk 9.5 mm) bild rivet
- 11. Antivibration clip
- 12. EJOT® Inox SAPHIR self drilling screw
- 13. INDEX DIN7981 HP 4.2x50 mm A2 pan-head screw
- 14. SIKATAACK PANEL 50 adhesive
- 15. 2-3 mm aluminium plate
- 16. LT-0A/B thermal break

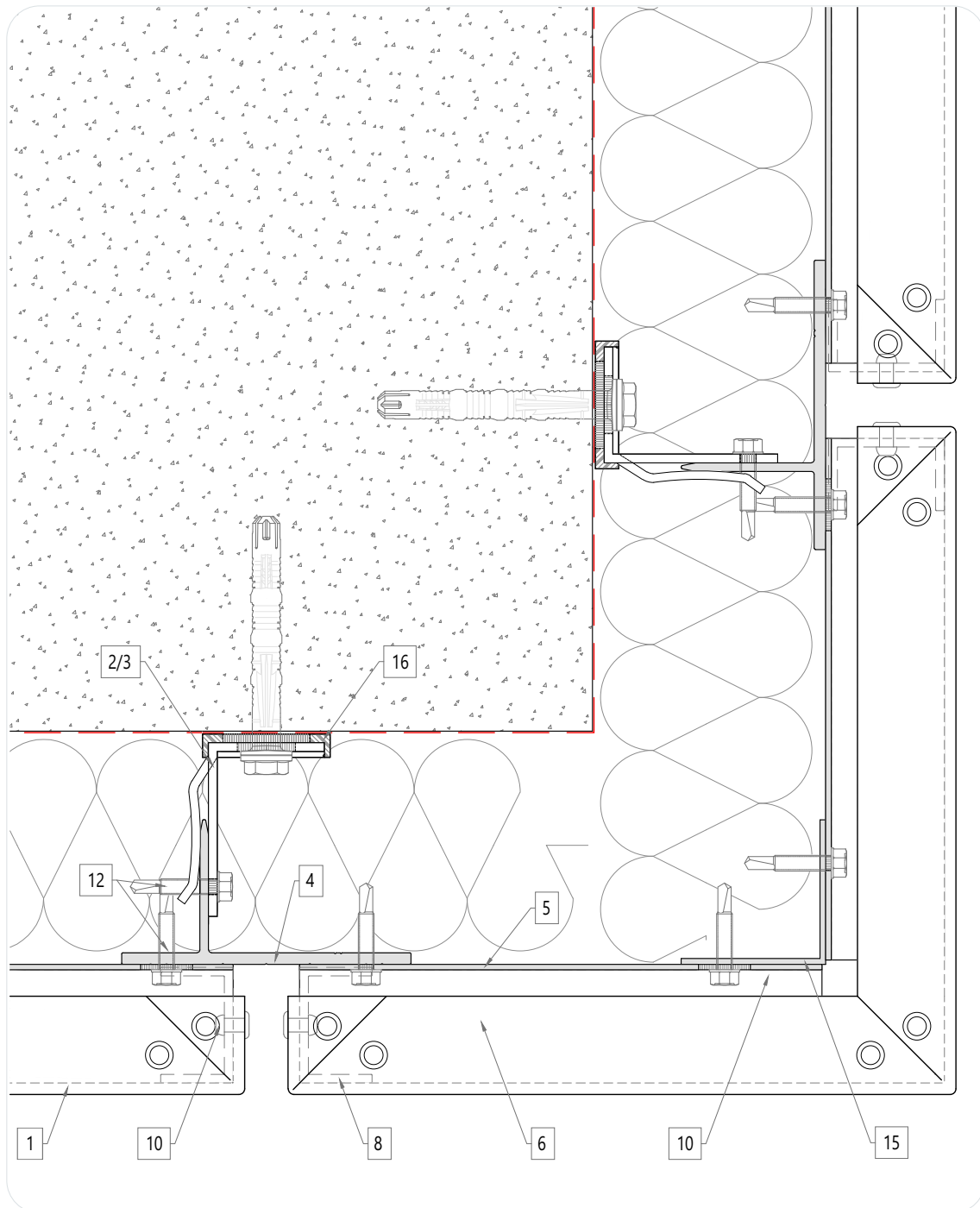

### 08a. External corner

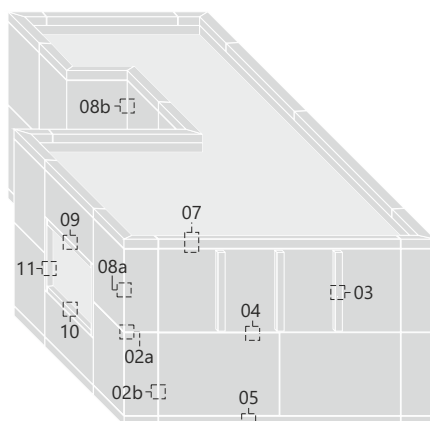

1. **larson®** composite panel
2. LT-1A wind-weight bracket
3. LT-1B wind bracket
4. LT-2 vertical profile
5. LC-4 profile
6. LC-6 profile
7. LC-RH intermediate vertical stiffener
8. LC-RC vertical edges stiffener
9. ISO 115977 4.8x10mm A1A/A2 (dk 9.5 mm) bind rivet
10. ISO 115977 4.8x12mm A1A/A2 (dk 9.5 mm) bild rivet
11. Antivibration clip
12. EJOT® Inox SAPHIR self drilling screw
13. INDEX DIN7981 HP 4.2x50 mm A2 pan-head screw
14. SIKATAACK PANEL 50 adhesive
15. 2-3 mm aluminium plate
16. LT-0A/B thermal break

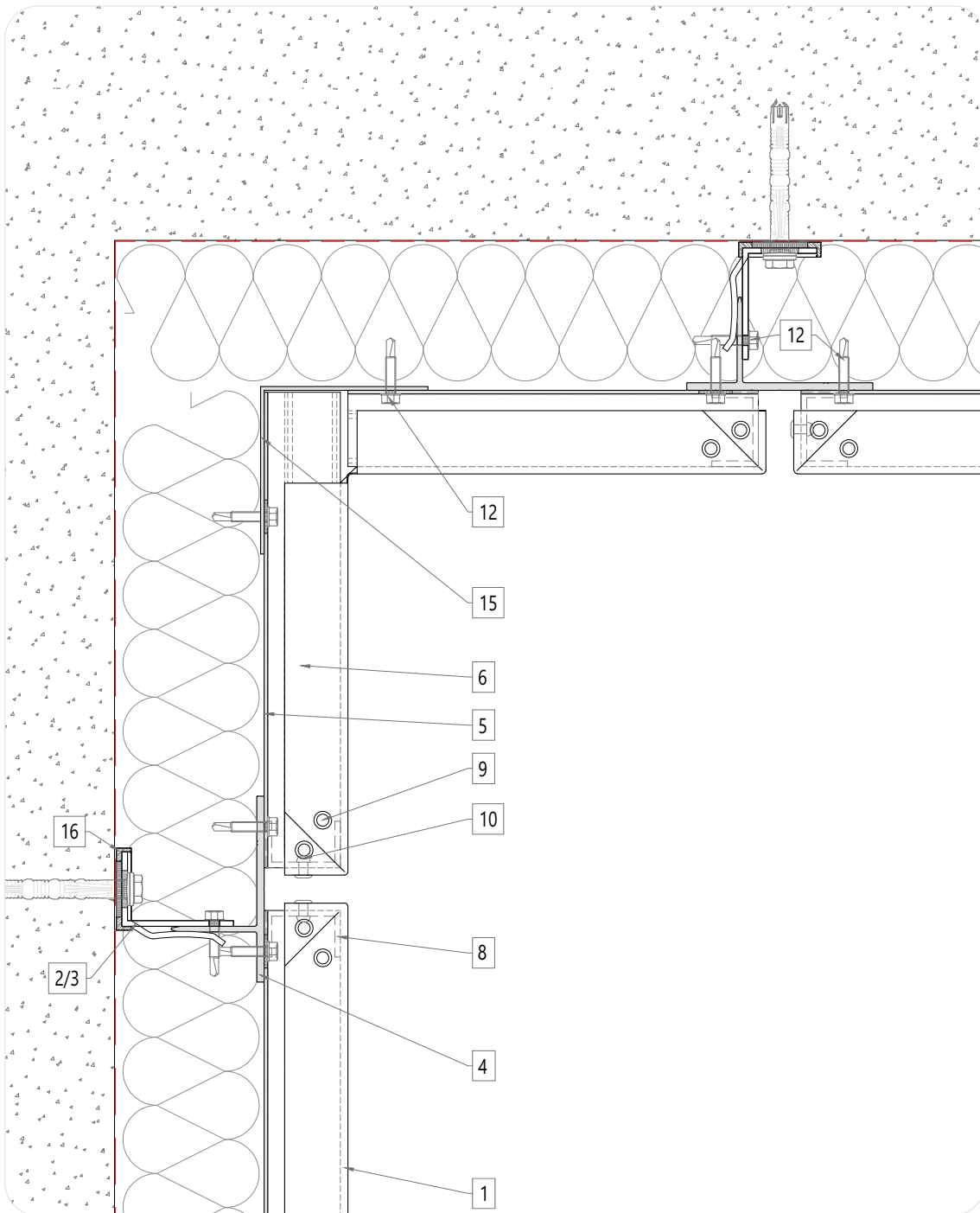

**08b. Internal corner**

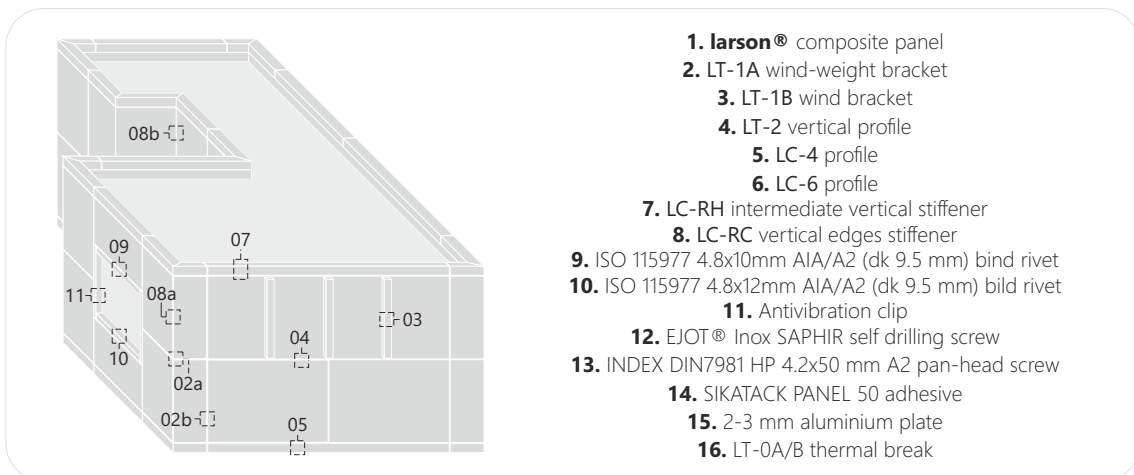

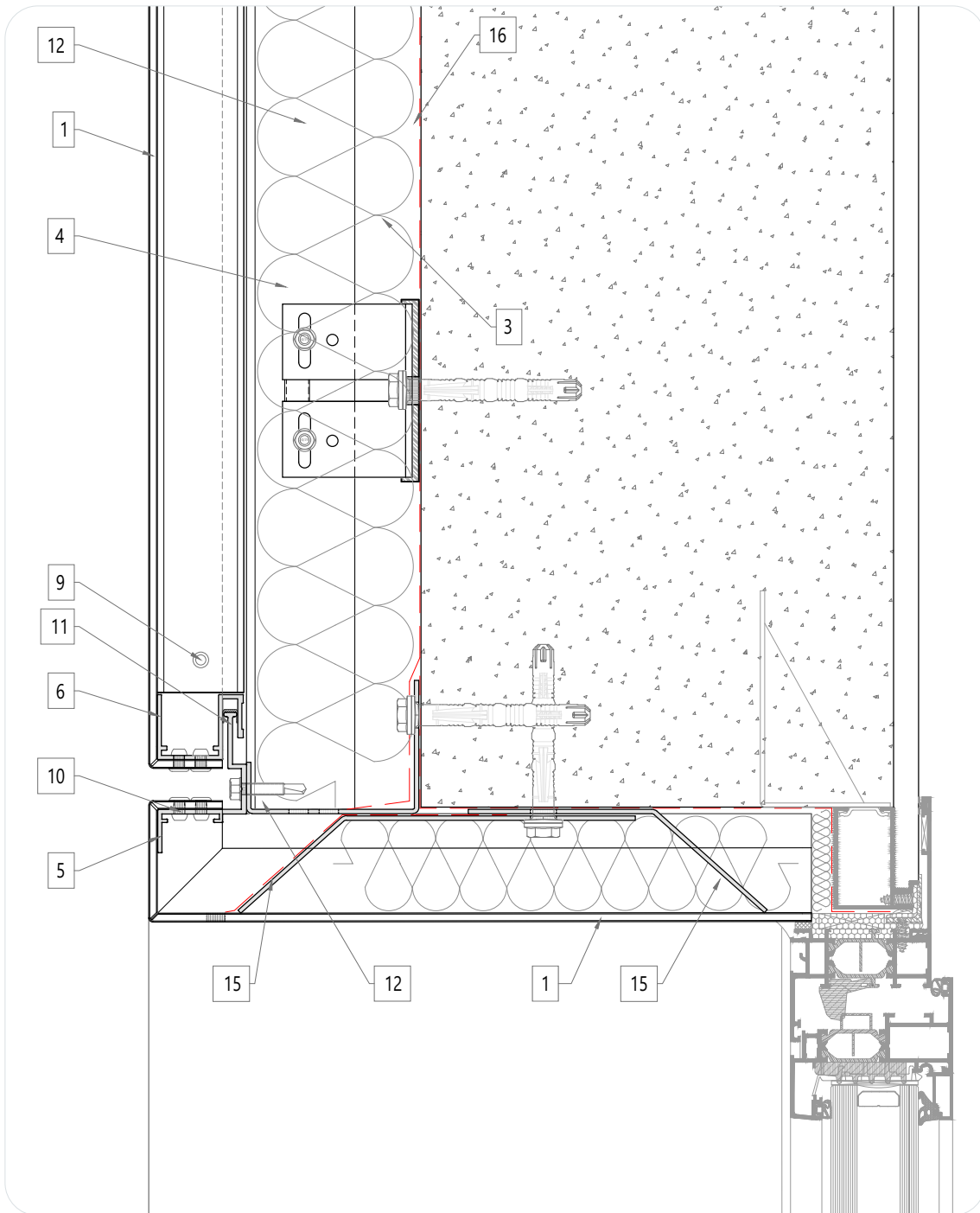

### 09. Window head detail

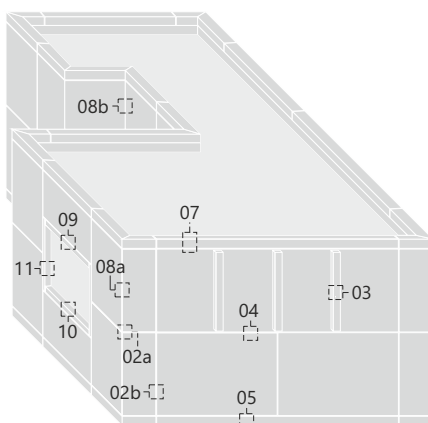

- 1. **larson®** composite panel
- 2. LT-1A wind-weight bracket
- 3. LT-1B wind bracket
- 4. LT-2 vertical profile
- 5. LC-4 profile
- 6. LC-6 profile
- 7. LC-RH intermediate vertical stiffener
- 8. LC-RC vertical edges stiffener
- 9. ISO 115977 4.8x10mm A1A/A2 (dk 9.5 mm) bind rivet
- 10. ISO 115977 4.8x12mm A1A/A2 (dk 9.5 mm) bild rivet
- 11. Antivibration clip
- 12. EJOT® Inox SAPHIR self drilling screw
- 13. INDEX DIN7981 HP 4.2x50 mm A2 pan-head screw
- 14. SIKATAACK PANEL 50 adhesive
- 15. 2-3 mm aluminium plate
- 16. LT-0A/B thermal break



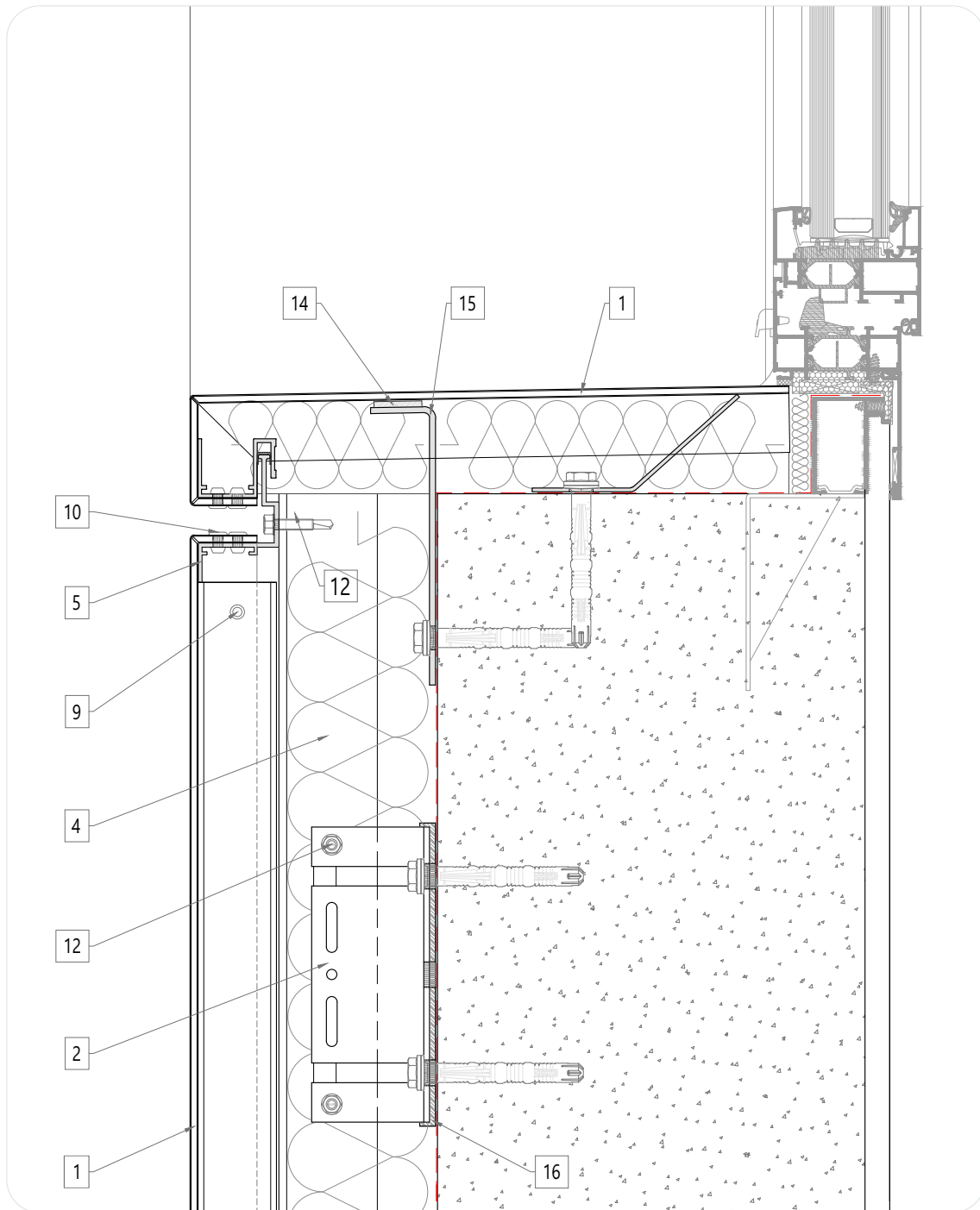

**10. Window sill detail**

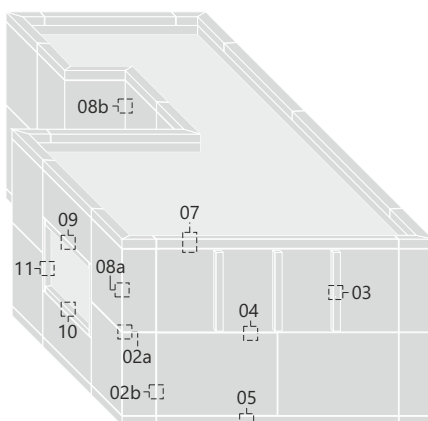

- 1. **larson®** composite panel
- 2. LT-1A wind-weight bracket
- 3. LT-1B wind bracket
- 4. LT-2 vertical profile
- 5. LC-4 profile
- 6. LC-6 profile
- 7. LC-RH intermediate vertical stiffener
- 8. LC-RC vertical edges stiffener
- 9. ISO 115977 4.8x10mm A1A/A2 (dk 9.5 mm) bind rivet
- 10. ISO 115977 4.8x12mm A1A/A2 (dk 9.5 mm) bild rivet
- 11. Antivibration clip
- 12. EJOT® Inox SAPHIR self drilling screw
- 13. INDEX DIN7981 HP 4.2x50 mm A2 pan-head screw
- 14. SIKATAACK PANEL 50 adhesive
- 15. 2-3 mm aluminium plate
- 16. LT-0A/B thermal break

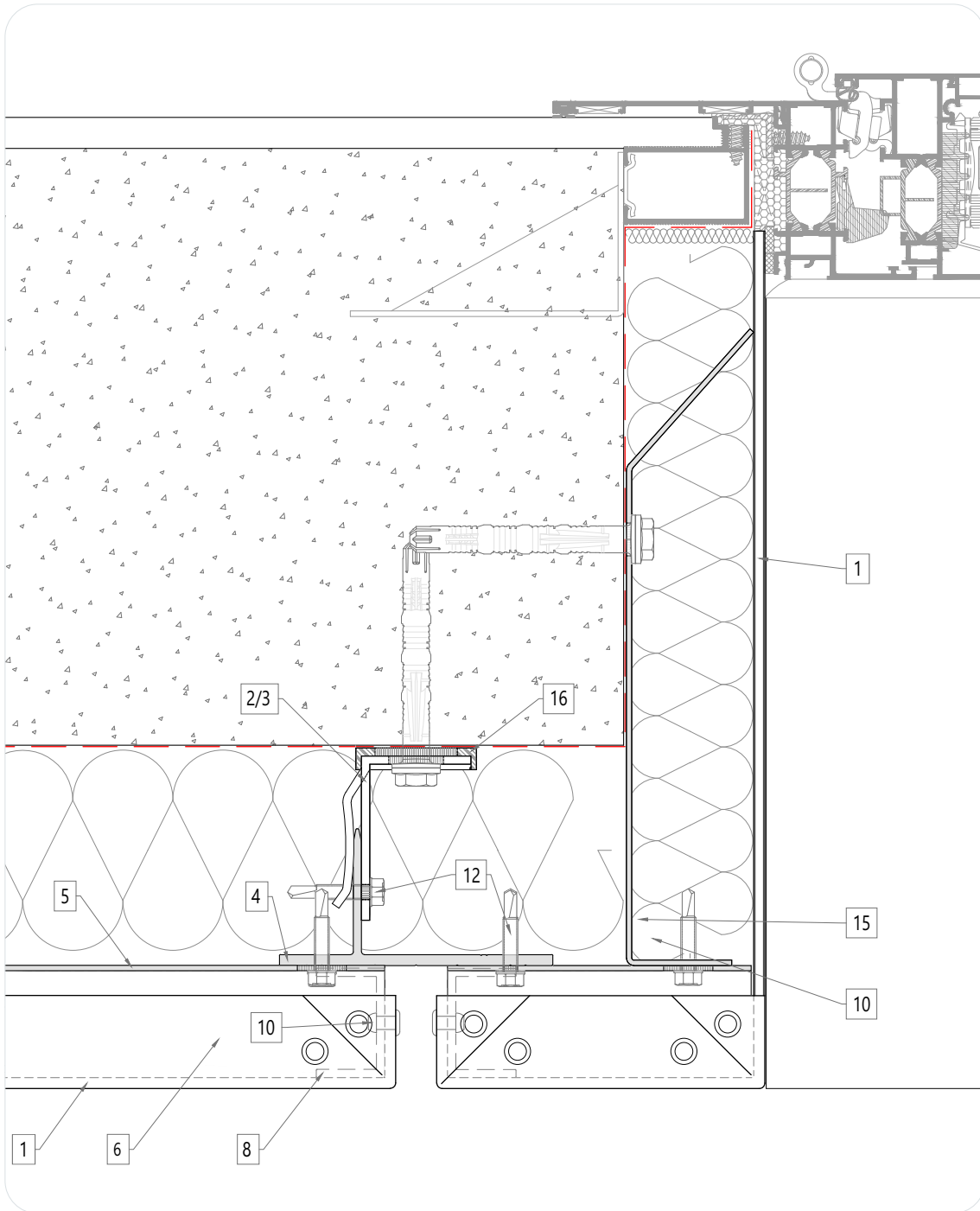

### 11. Window jamb detail

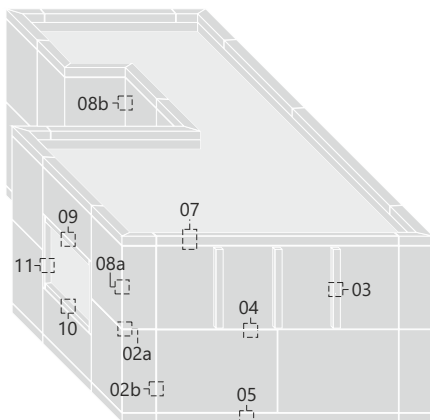

- 1. **larson®** composite panel
- 2. LT-1A wind-weight bracket
- 3. LT-1B wind bracket
- 4. LT-2 vertical profile
- 5. LC-4 profile
- 6. LC-6 profile
- 7. LC-RH intermediate vertical stiffener
- 8. LC-RC vertical edges stiffener
- 9. ISO 115977 4.8x10mm A1A/A2 (dk 9.5 mm) bind rivet
- 10. ISO 115977 4.8x12mm A1A/A2 (dk 9.5 mm) bild rivet
- 11. Antivibration clip
- 12. EJOT® Inox SAPHIR self drilling screw
- 13. INDEX DIN7981 HP 4.2x50 mm A2 pan-head screw
- 14. SIKATAACK PANEL 50 adhesive
- 15. 2-3 mm aluminium plate
- 16. LT-0A/B thermal break



LC4-LC6 system "**larson**<sup>®</sup> cassettes"  
MOCK UP - Render drawn by SolidWorks

# larson<sup>®</sup>





## RIVETED system "larson® panels"

### 01. Outside façade

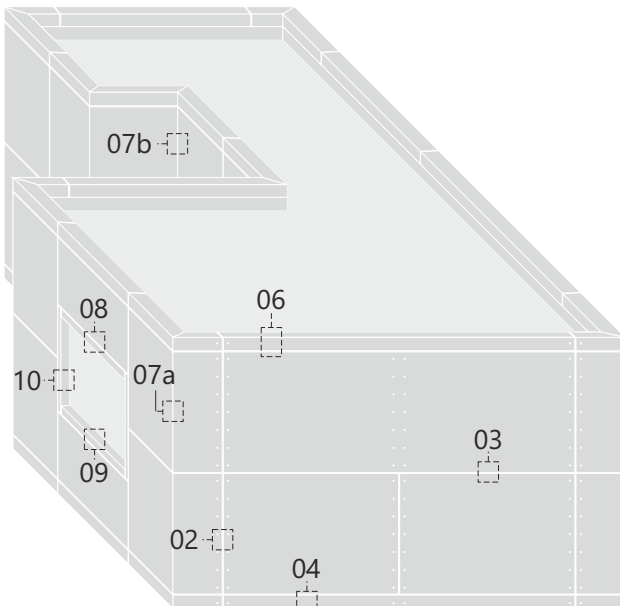
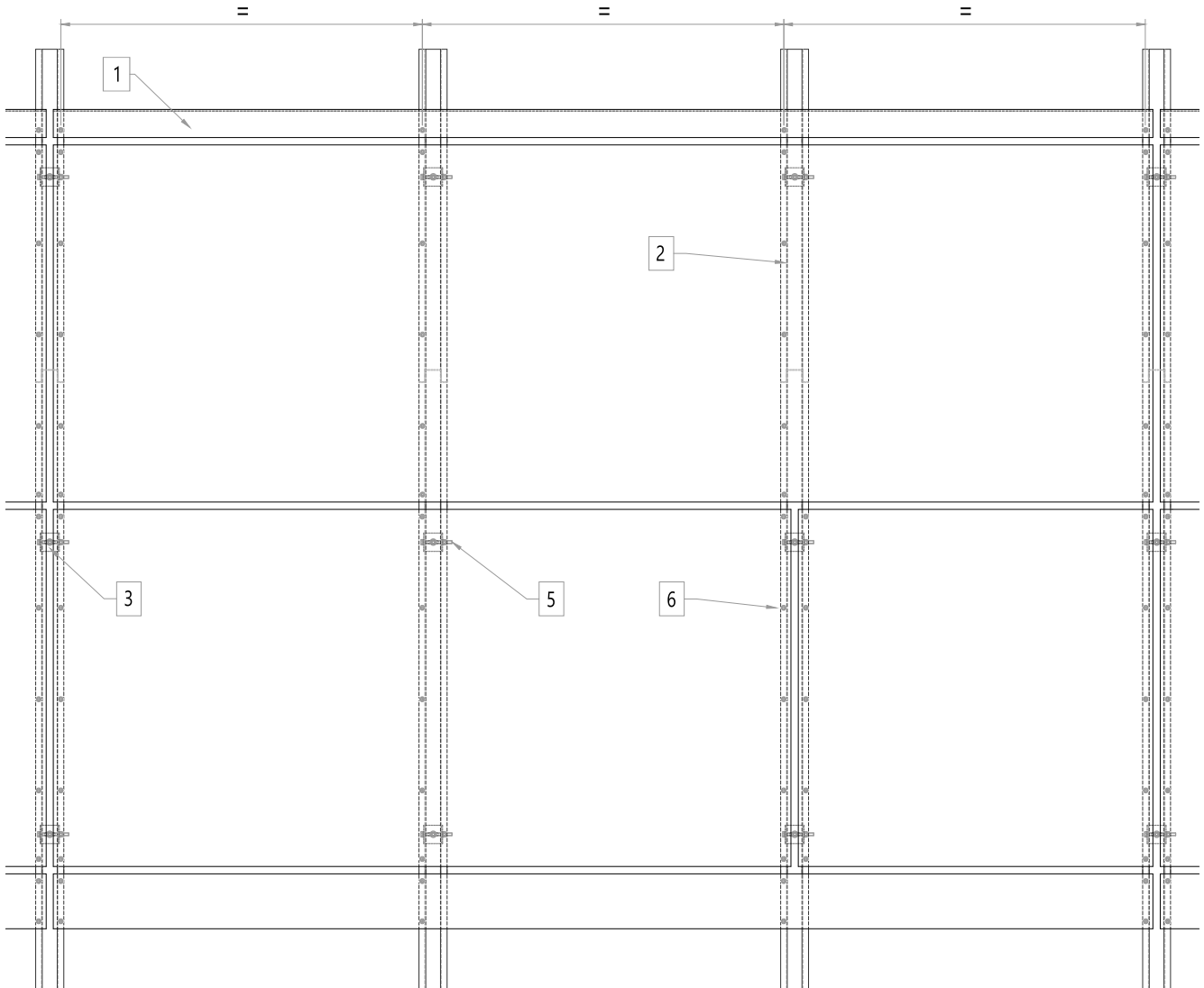

- 1. larson® composite panel
- 2. LCH-1 vertical profile
- 3. LCH-2 bracket
- 4. 2-3 mm aluminium plate
- 5. DIN 933 M8x80 mm 8.8 hex head screw  
DIN 125 M8 8.8 (x2) washer  
DIN 934 M8 8.8 hex nut
- 6. ISO 15977 5x12 mm A1A/A2 (dk 14 mm) blind rivet
- 7. DIN 7504-K4.8x22 mm A2/50 self-drilling screw
- 8. SIKATAK PANEL 50 adhesive

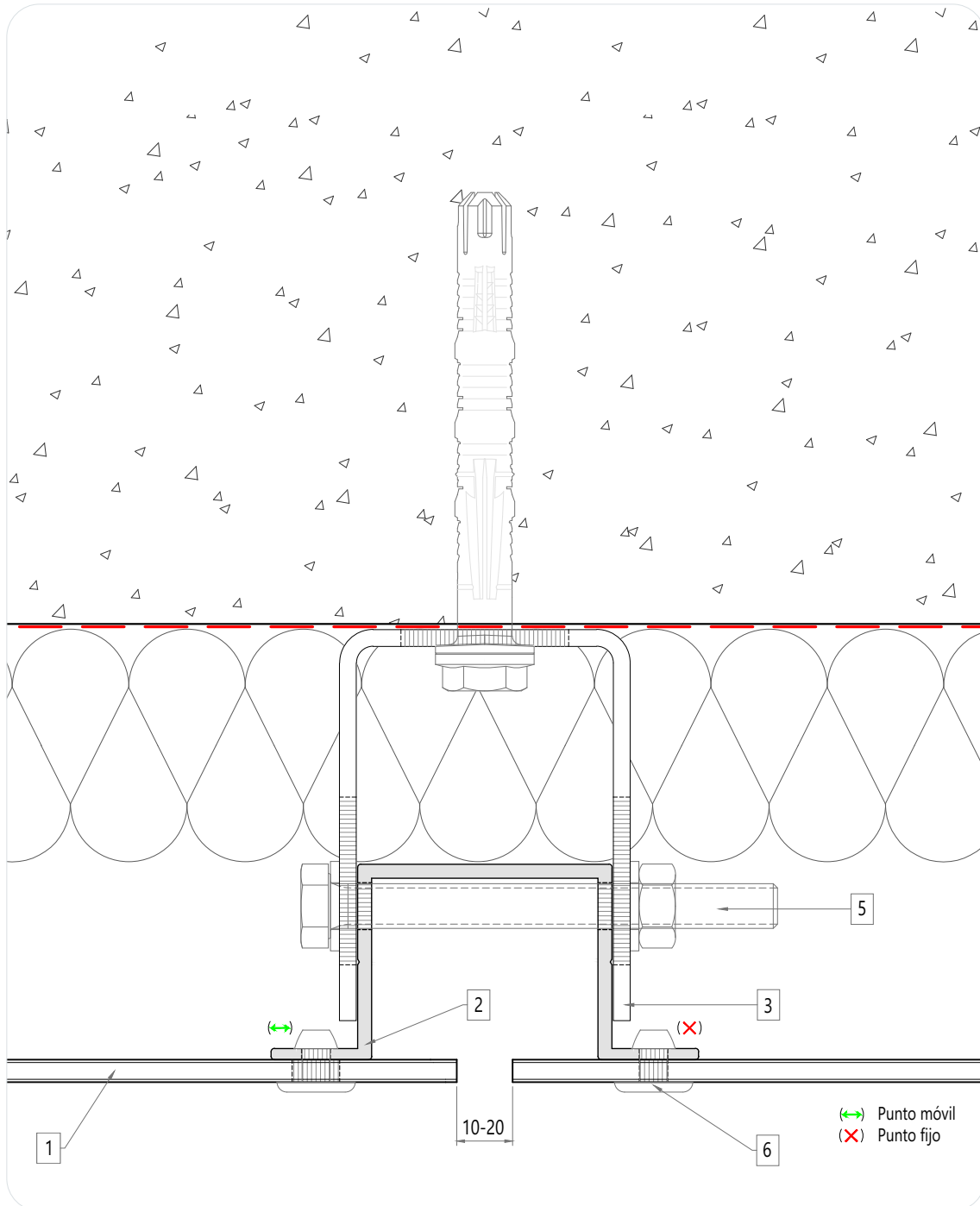

## 02. Vertical joint

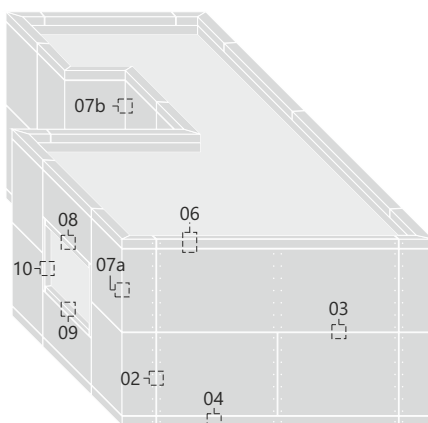

1. **larson®** composite panel
2. LCH-1 vertical profile
3. LCH-2 bracket
4. 2-3 mm aluminium plate
5. DIN 933 M8x80 mm 8.8 hex head screw  
DIN 125 M8 8.8 (x2) washer  
DIN 934 M8 8.8 hex nut
6. ISO 15977 5x12 mm A1A/A2 (dk 14 mm) blind rivet
7. DIN 7504-K4.8x22 mm A2/50 self-drilling screw
8. SIKATAACK PANEL 50 adhesive

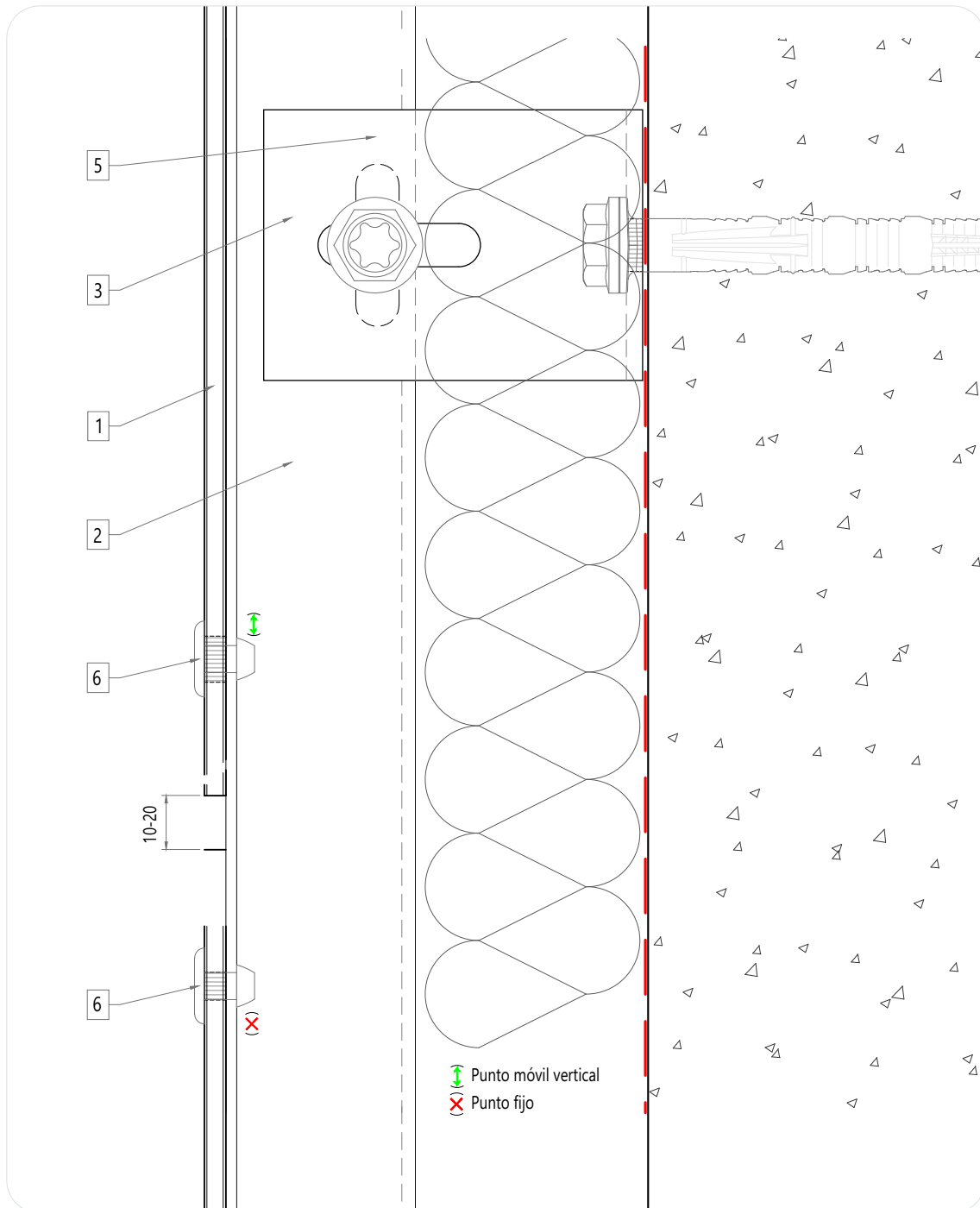

### 03. Horizontal joint

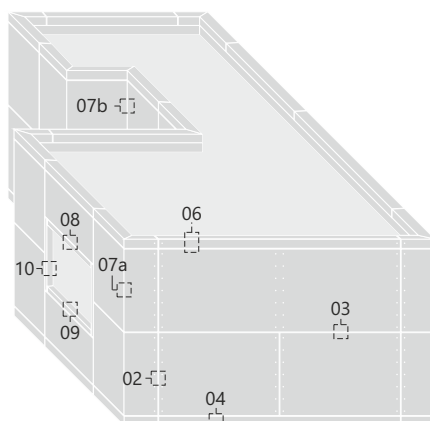

1. **larson®** composite panel
2. LCH-1 vertical profile
3. LCH-2 bracket
4. 2-3 mm aluminium plate
5. DIN 933 M8x80 mm 8.8 hex head screw  
DIN 125 M8 8.8 (x2) washer  
DIN 934 M8 8.8 hex nut
6. ISO 15977 5x12 mm A1A/A2 (dk 14 mm) blind rivet
7. DIN 7504-K4.8x22 mm A2/50 self-drilling screw
8. SIKATAACK PANEL 50 adhesive

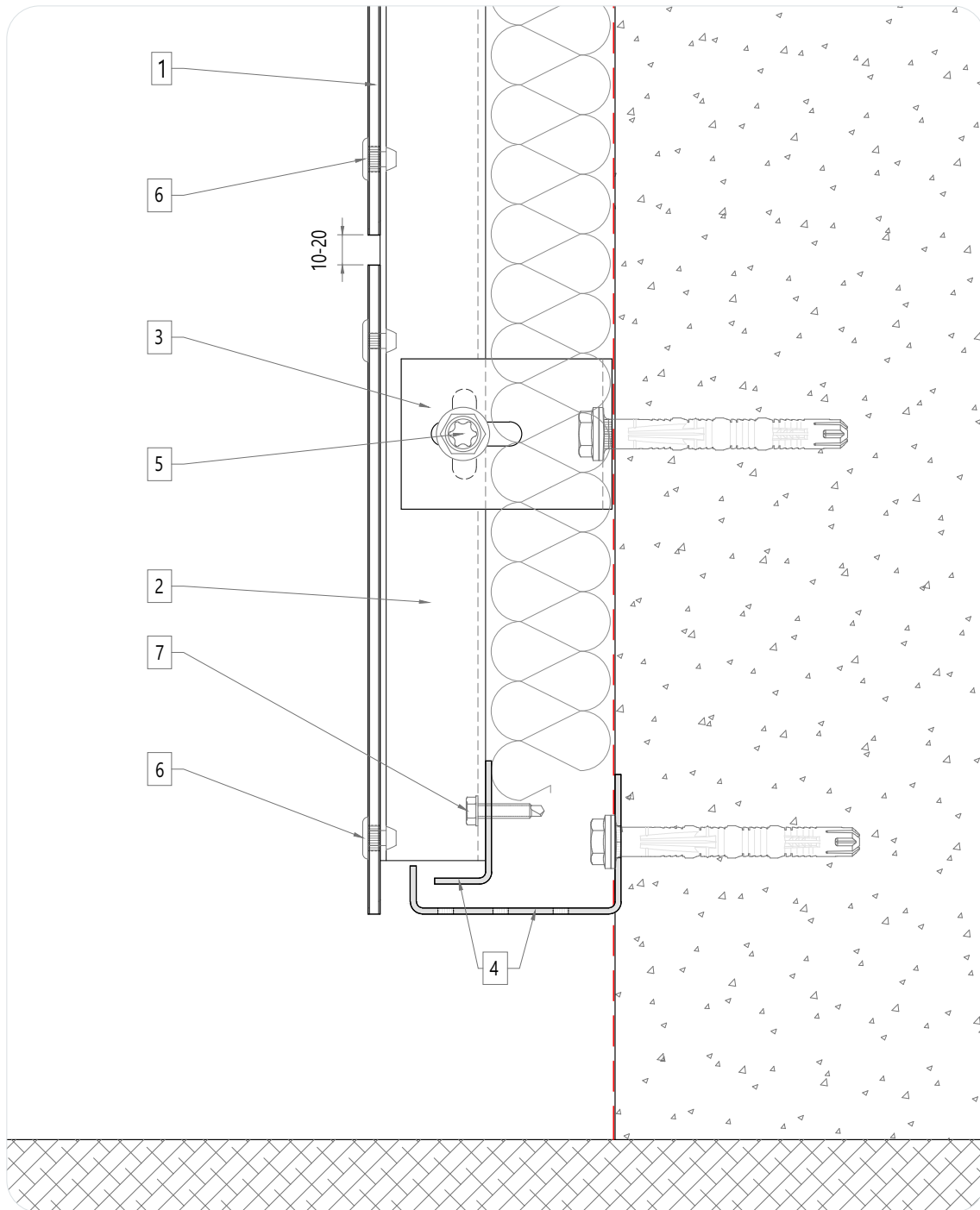

#### 04. Starting façade

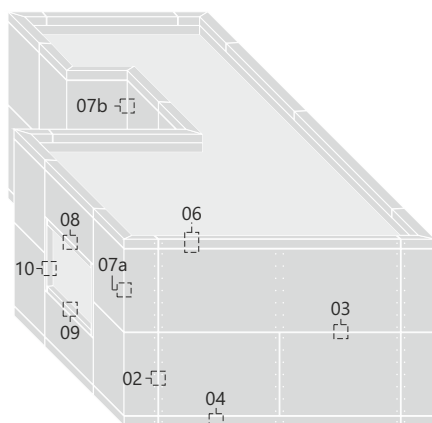

1. **larson®** composite panel
2. LCH-1 vertical profile
3. LCH-2 bracket
4. 2-3 mm aluminium plate
5. DIN 933 M8x80 mm 8.8 hex head screw  
DIN 125 M8 8.8 (x2) washer  
DIN 934 M8 8.8 hex nut
6. ISO 15977 5x12 mm A1A/A2 (dk 14 mm) blind rivet
7. DIN 7504-K4.8x22 mm A2/50 self-drilling screw
8. SIKATAACK PANEL 50 adhesive

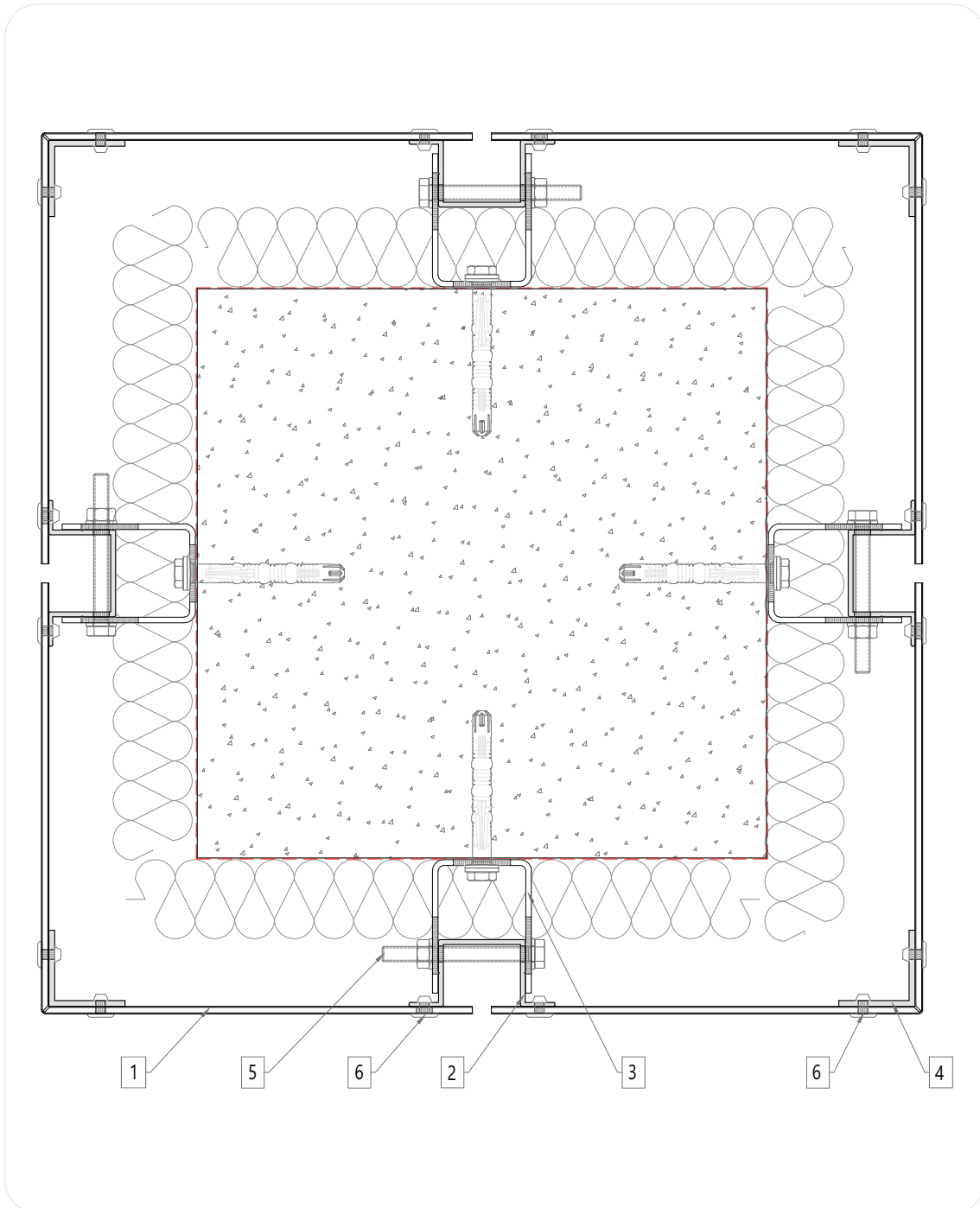

## 05. Columns

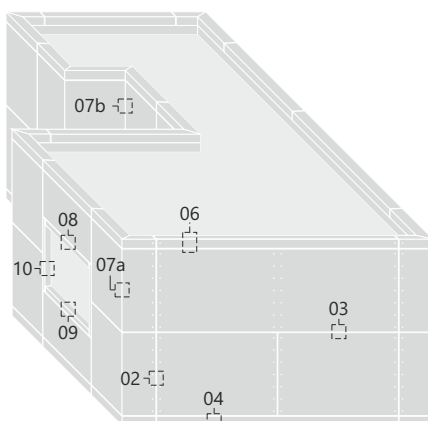

1. **larson®** composite panel
2. LCH-1 vertical profile
3. LCH-2 bracket
4. 2-3 mm aluminium plate
5. DIN 933 M8x80 mm 8.8 hex head screw  
DIN 125 M8 8.8 (x2) washer  
DIN 934 M8 8.8 hex nut
6. ISO 15977 5x12 mm A1A/A2 (dk 14 mm) blind rivet
7. DIN 7504-K4.8x22 mm A2/50 self-drilling screw
8. SIKATAACK PANEL 50 adhesive



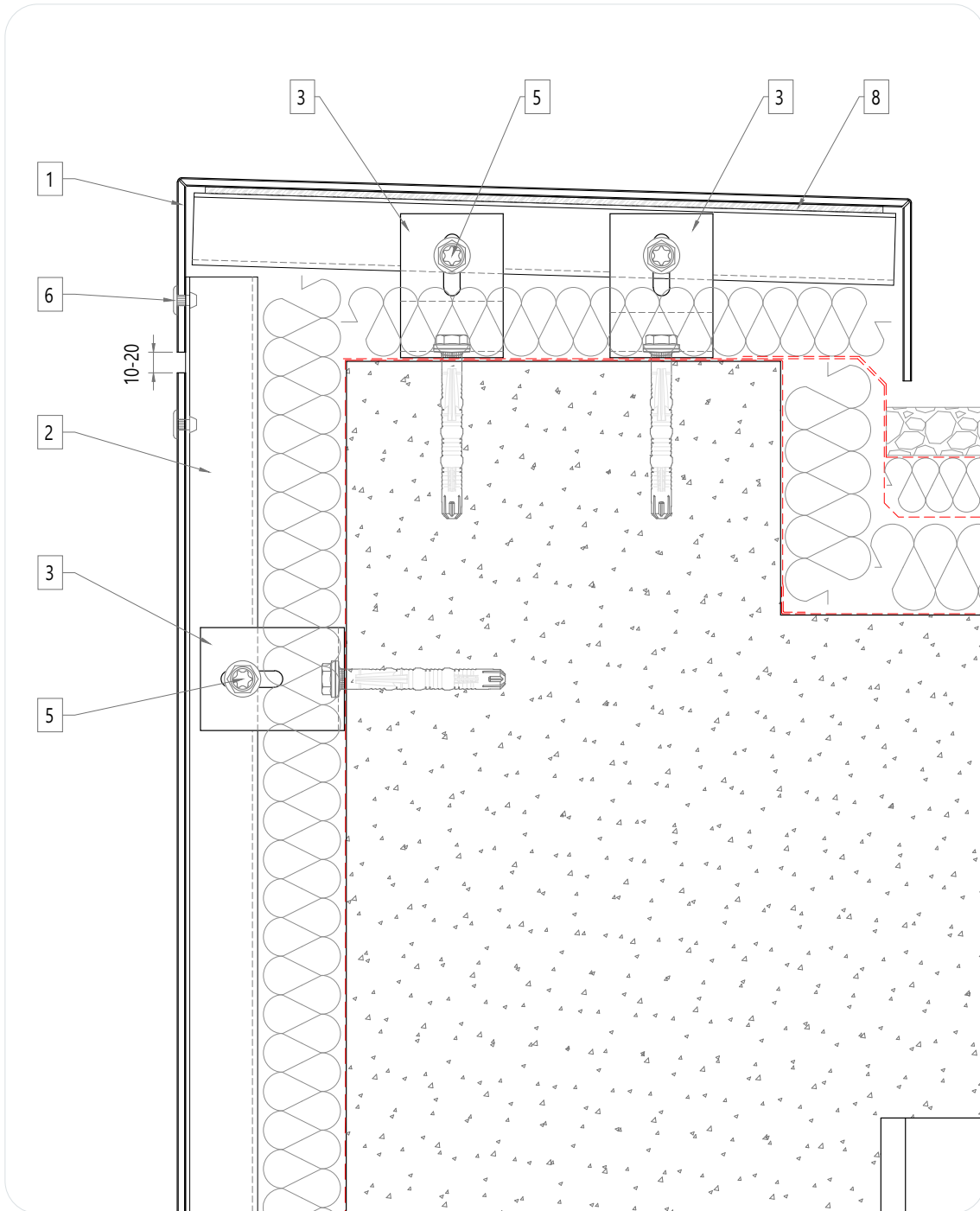

## 06. Parapet detail

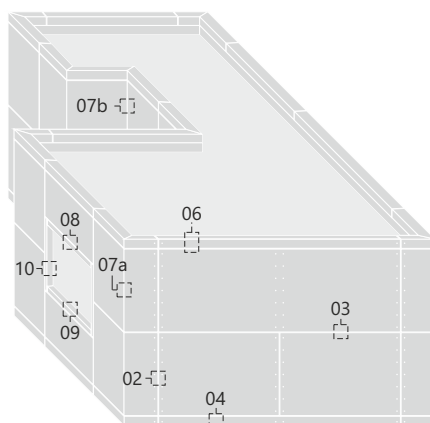

1. larson® composite panel
2. LCH-1 vertical profile
3. LCH-2 bracket
4. 2-3 mm aluminium plate
5. DIN 933 M8x80 mm 8.8 hex head screw  
DIN 125 M8 8.8 (x2) washer  
DIN 934 M8 8.8 hex nut
6. ISO 15977 5x12 mm A1A/A2 (dk 14 mm) blind rivet
7. DIN 7504-K4.8x22 mm A2/50 self-drilling screw
8. SIKATAACK PANEL 50 adhesive

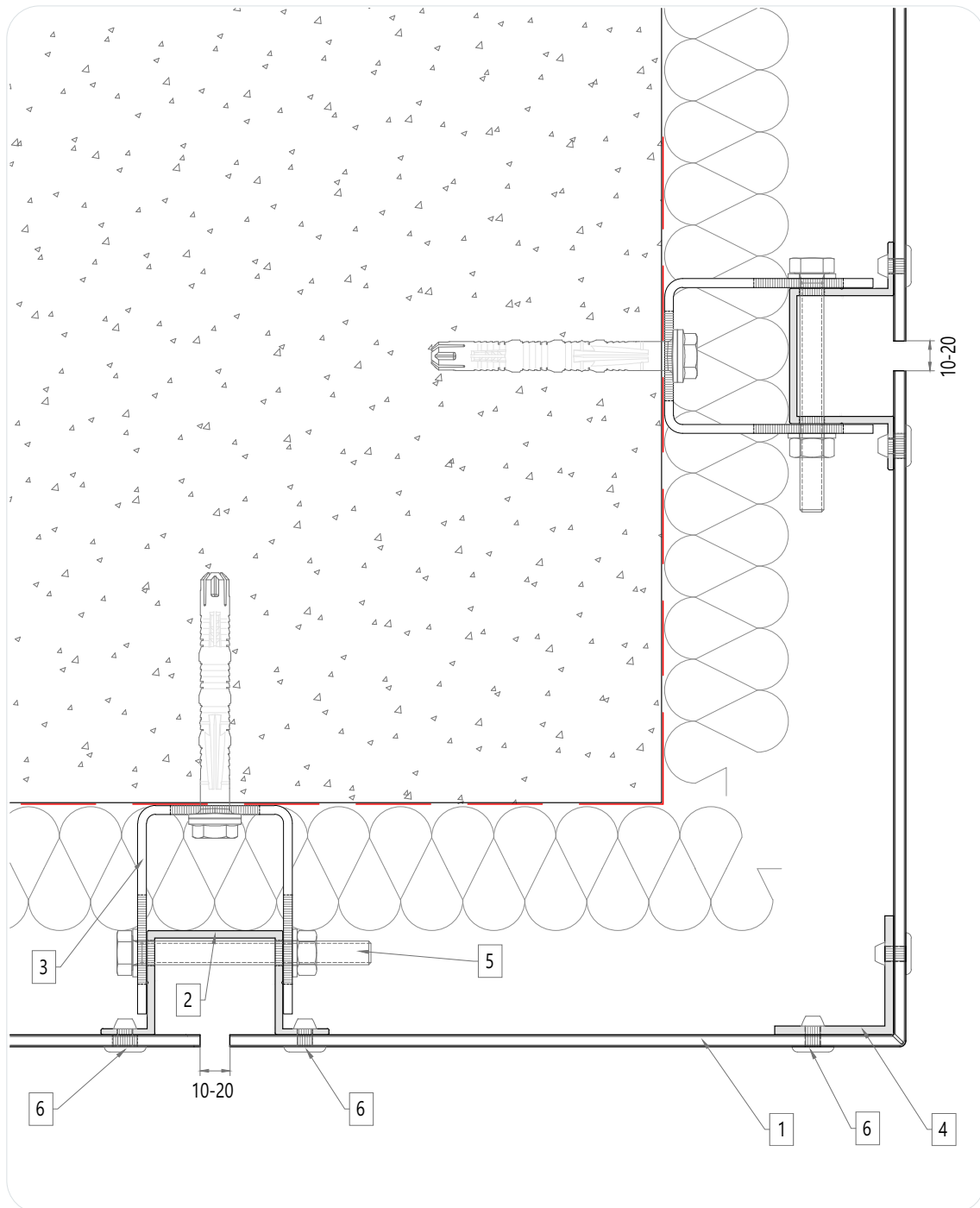

**07a. External corner**

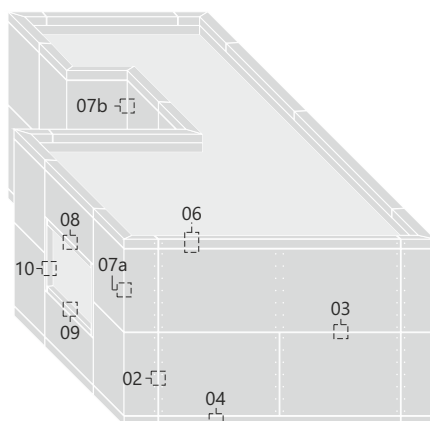

1. larson® composite panel
2. LCH-1 vertical profile
3. LCH-2 bracket
4. 2-3 mm aluminium plate
5. DIN 933 M8x80 mm 8.8 hex head screw  
DIN 125 M8 8.8 (x2) washer  
DIN 934 M8 8.8 hex nut
6. ISO 15977 5x12 mm A1A/A2 (dk 14 mm) blind rivet
7. DIN 7504-K4.8x22 mm A2/50 self-drilling screw
8. SIKATAACK PANEL 50 adhesive

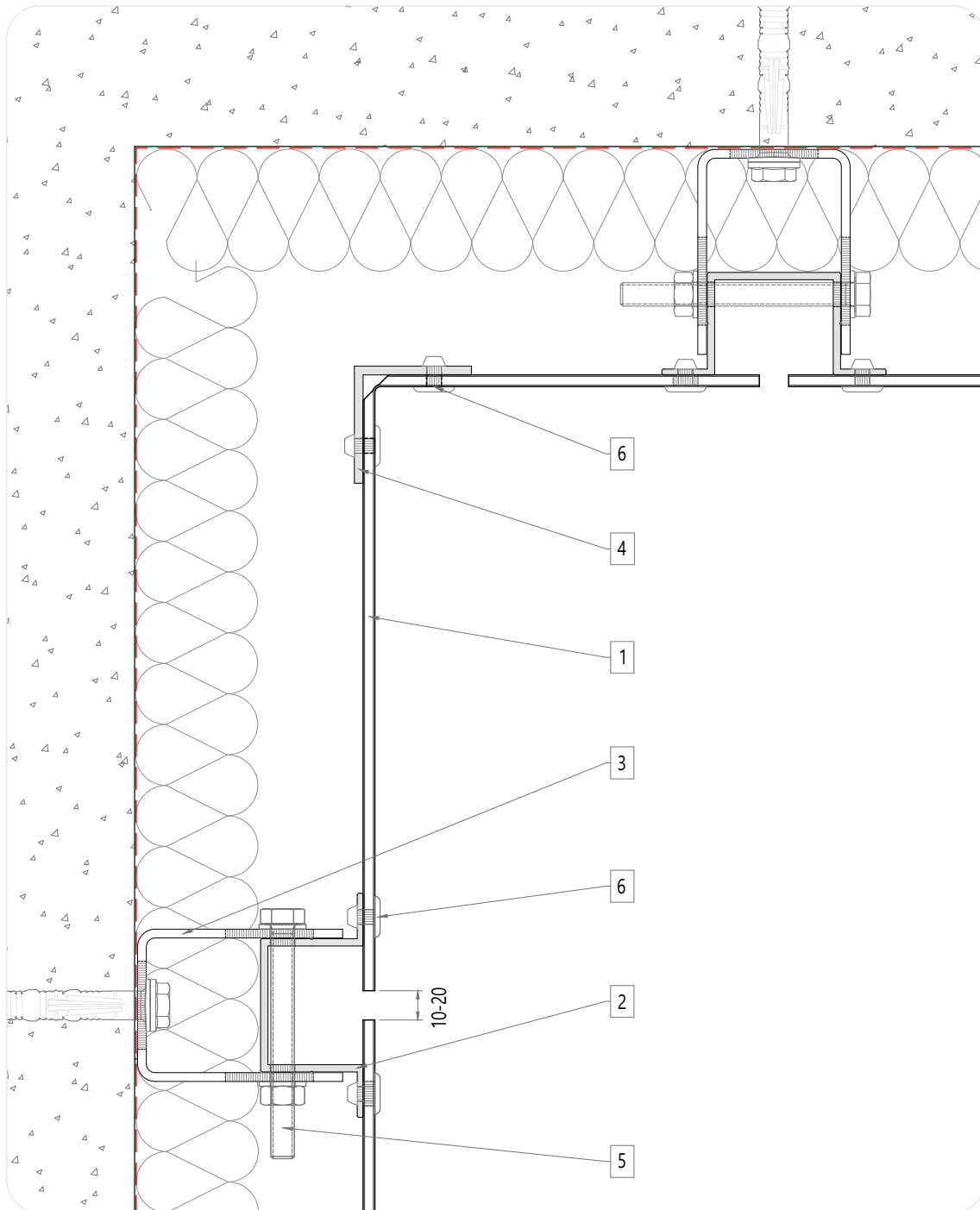

**07b. Internal corner**

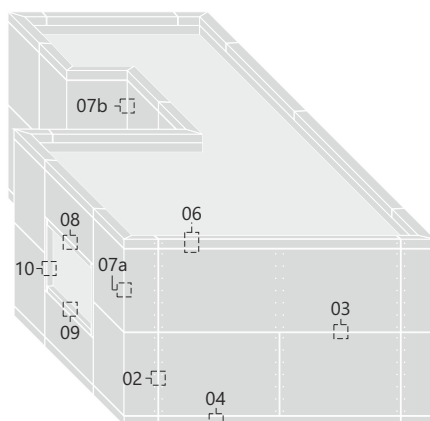

1. **larson®** composite panel
2. LCH-1 vertical profile
3. LCH-2 bracket
4. 2-3 mm aluminium plate
5. DIN 933 M8x80 mm 8.8 hex head screw  
DIN 125 M8 8.8 (x2) washer  
DIN 934 M8 8.8 hex nut
6. ISO 15977 5x12 mm A1A/A2 (dk 14 mm) blind rivet
7. DIN 7504-K4.8x22 mm A2/50 self-drilling screw
8. SIKATAACK PANEL 50 adhesive

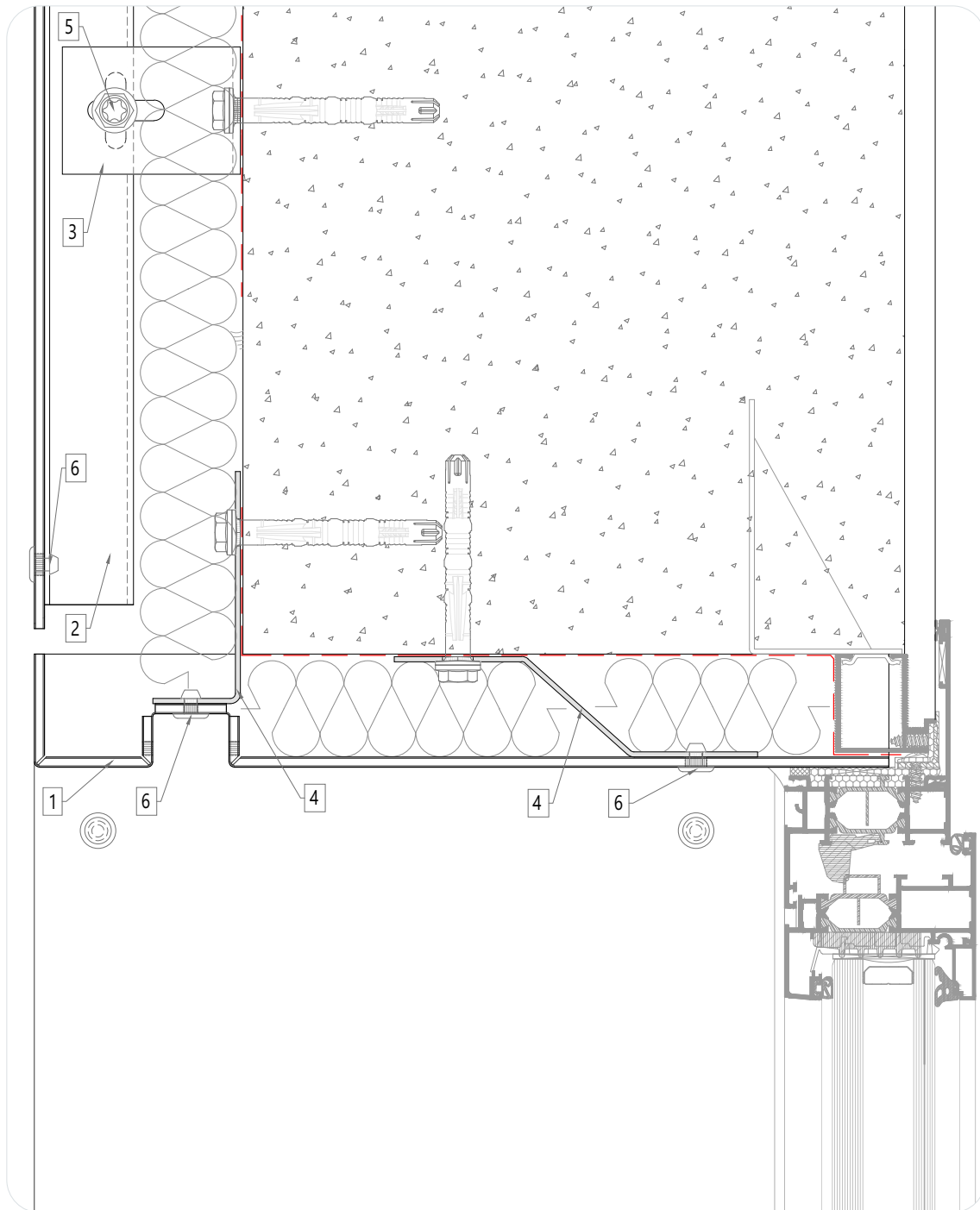

### 08. Window head detail

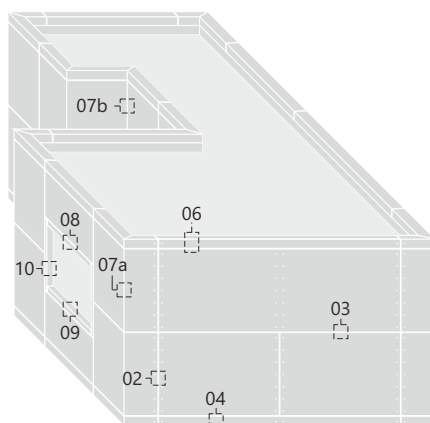

- 1. **larson®** composite panel
- 2. LCH-1 vertical profile
- 3. LCH-2 bracket
- 4. 2-3 mm aluminium plate
- 5. DIN 933 M8x80 mm 8.8 hex head screw  
DIN 125 M8 8.8 (x2) washer  
DIN 934 M8 8.8 hex nut
- 6. ISO 15977 5x12 mm A1A/A2 (dk 14 mm) blind rivet
- 7. DIN 7504-K4.8x22 mm A2/50 self-drilling screw
- 8. SIKATAACK PANEL 50 adhesive

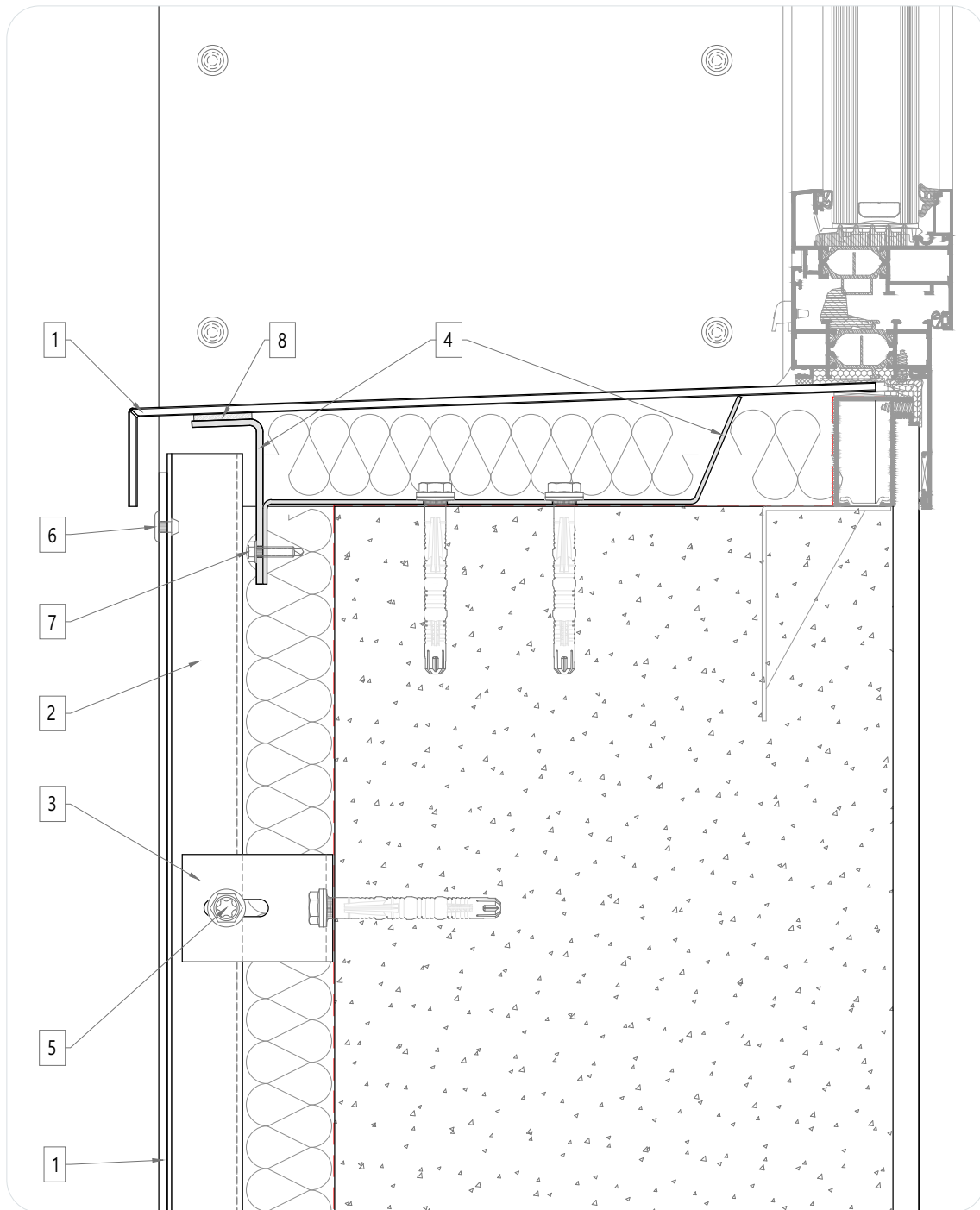

### 9. Window sill detail

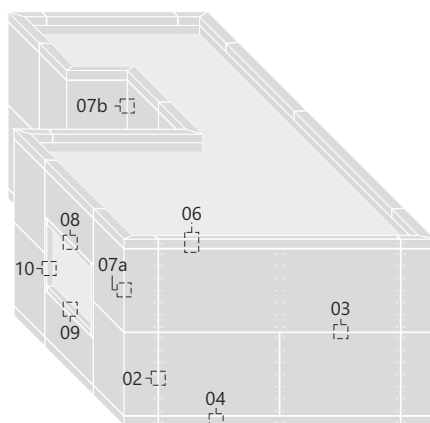

1. **larson®** composite panel
2. LCH-1 vertical profile
3. LCH-2 bracket
4. 2-3 mm aluminium plate
5. DIN 933 M8x80 mm 8.8 hex head screw  
DIN 125 M8 8.8 (x2) washer  
DIN 934 M8 8.8 hex nut
6. ISO 15977 5x12 mm A1A/A2 (dk 14 mm) blind rivet
7. DIN 7504-K4.8x22 mm A2/50 self-drilling screw
8. SIKATAACK PANEL 50 adhesive

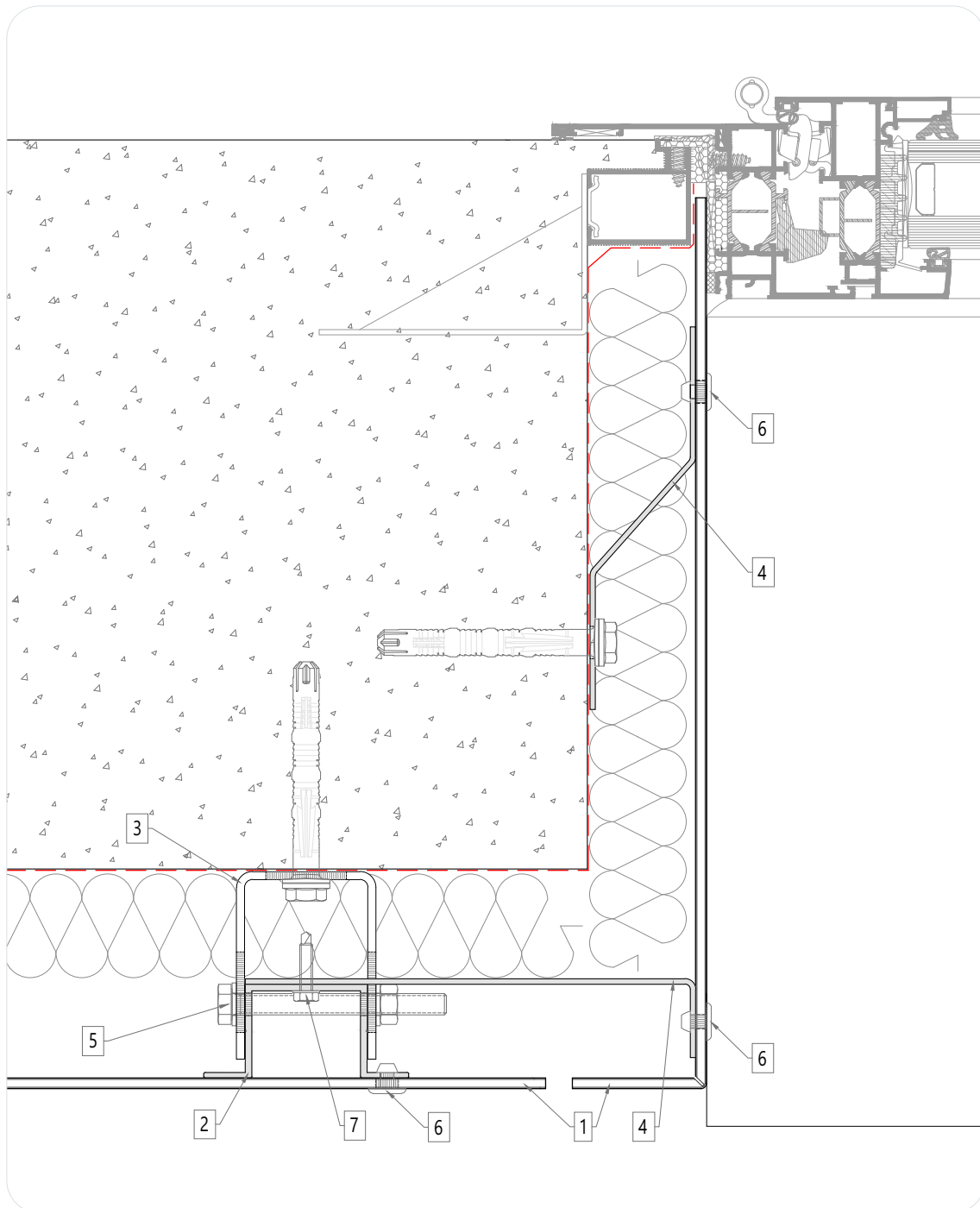

### 10. Window jamb detail

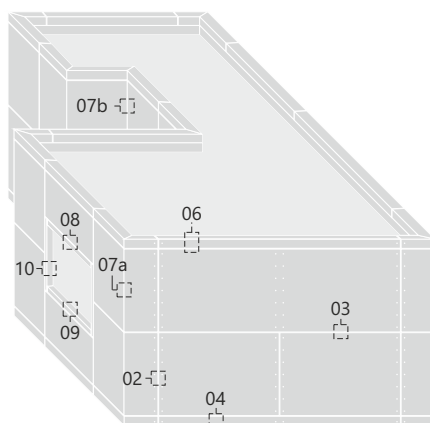

- 1. **larson®** composite panel
- 2. LCH-1 vertical profile
- 3. LCH-2 bracket
- 4. 2-3 mm aluminium plate
- 5. DIN 933 M8x80 mm 8.8 hex head screw  
DIN 125 M8 8.8 (x2) washer  
DIN 934 M8 8.8 hex nut
- 6. ISO 15977 5x12 mm A1A/A2 (dk 14 mm) blind rivet
- 7. DIN 7504-K4.8x22 mm A2/50 self-drilling screw
- 8. SIKATAACK PANEL 50 adhesive



RIVETED system "larson<sup>®</sup> panels"  
MOCK UP - Render drawn by SolidWorks

# larson<sup>®</sup>





## APPENDIX I.

### Specific considerations for **larson**<sup>®</sup> **A2** panel

**Alucoil**<sup>®</sup> recommends machining tests on this product.

- The folding of the edges must never be done manually. It must be done with an appropriate tool which covers all the area to be folded. The folding of the edge of the panel must be done in one folding operation covering the full edge and not by steps starting on the corner, then the centre and later the end.
- Only one fold must be done to reach the desired angle. A bigger angle should not be folded to later fold back to reach the desired angle.
- Due to the nature of the A2 mineral core, it is recommended to lower the routing/milling of the core for the later folding of edges later. Some core should always be left, voiding to see the aluminium skin.
- To ensure a correct folding of **larson**<sup>®</sup> **A2** panels, **Alucoil**<sup>®</sup> recommends to make the folding process with a panel temperature higher than 17°C.

(CRACKING MAY APPEAR ON THE SURFACE OF THE PANEL IF THESE INDICATIONS ARE NOT FOLLOWED).

## APPENDIX 2

### INFORMATION ABOUT SPECIAL FINISHES

#### **ANODIZED SURFACES**

The anodic film is the transformation of aluminum in aluminum oxide up to certain depth or film thickness.

#### HANDLING/PACKAGING

The handling of continuous anodized products must be carried out by personnel with experience with this type of material. This product is very sensitive, any non-uniform tension or stress created in the metal can generate non-uniform crazing. Therefore, throughout the transformation process, each piece of equipment (leveler, cut to length, slitting machine, swaging etc.) must be set-up to take account of this sensitivity. The packaging of the material must be undertaken without introducing any non-uniform tension in the metal.

Failure to observe the above precautions can cause:

- Increased crazing
- Creation of non-uniform crazing (which will result non-uniform appearance)
- In some cases the destruction of the anodic film layer (blemishes, dust etc.)

#### BENDING OF REAL ANODIZED

Real anodized should only be bent under certain conditions and with the appropriate know-how.

#### General considerations:

**Crazing:** If continuously anodised aluminium is folded, the anodic film of aluminium oxide will crack and 'crazing' will be formed. This crazing is not a problem for the corrosion resistance and should not be a problem in terms of aesthetics if the bending is executed properly.

**No filiform corrosion – natural oxidation:** Real Anodized is pure aluminium and aluminium oxide. The anodic film is integral with the core material. If the anodised surface is cracked by folding this is not really a problem because this zone will be re-oxidised immediately by the oxygen present in the atmosphere and no corrosion or filiform corrosion will be generated.

**Aesthetic effect:** The only real area of concern can be the aesthetic effect in the bending zone. Crazing occurs as fine white lines and may cause whitening effect in the bent zones. The objective is to contain the cracking in the folded area only and to not affect the rest of the panel.

#### Bending recommendations:

**Film:** The surface must be protected by a protective film to avoid any marks of the mechanized machine on the surface and the quality of the equipment is fundamental and an adaptive folding machines are recommended.





**Bending radius:** The selection of the bending radius is a key factor of success. The challenge is to find a good balance between the aesthetic and mechanical characteristics.

To limit the crazing inside the bending area, it is recommended to use a bending radius as small as possible. However, the use of a small bending radius can affect the mechanical resistance of the material. So, a good balance has to be found in each case.

The EN-485-2 standard contains the minimum 'recommended' bending radius per alloy and temper at which no cracking (of the metal) is observed. Severe cracking may cause real deterioration in the metal strength around the bend (so it is not just an optical phenomenon).

- The crazing will result in a whitening of the surface and will be, therefore, more visible in darker colours.
- The visibility of the crazing depends also on the viewing distance.
- The thinner the metal, the better bending results will be achieved.
- Protect the surface with an appropriate protection film before bending.
- Depending on the metal sheet, there will be a difference in bending behaviour between bending parallel and opposite to the rolling direction.

#### CUT-TO-LENGTH-WIDTH AND PROTECTION OF CUT EDGES

In order to achieve sheets with perfect flatness without damaging the anodic film layer a specialist process involving a particular specification of cut-to-length line and specialist operators must be performed.

#### Technical considerations for cut-to-length

Special attention should be given on the cleaning of the cut-to-length line before processing, including:

- Removal of aluminium particles
- Pull cleaning felt through the line
- Working in production campaigns

#### During the cut-to-length process:

- Use oil or lubricant during levelling.
- Avoid too much pressure which can damage the anodic layer

#### Cut edges

Real Anodized does not suffer from filiform corrosion and, therefore, there is no risk of the propagation of corrosion affecting the flat surfaces of the sheet after cut-to-length. The cut surface of the aluminium will oxidise naturally and rapidly, thereby ensuring adequate surface protection of the cut surface.

#### RECOMMENDATIONS FOR THE FIXING OF **larson®** Real Anodized ALUMINIUM COMPOSITE PANELS

**It is highly recommended to install **larson®** Real Anodized panels from the same production batch in the same facade to avoid tonality issues.**

#### Orientation of the panels:

Special care must be extended to the orientation of the panels (direction and sense) as a consequence of the mill line direction. A panel oriented parallel or perpendicular with the mill direction will present two different shades.

**larson®**'s panels show in the protector film and printed in the internal face of each panel, the sense of the arrow, to indicate mill direction.

#### Vertical orientation recommended:

It is recommended to install the panels vertically and not horizontally or oriented with an angle less or equal to 45°. It is important to avoid design allowing the accumulation of liquid, fluid on the surface. It is also important that panels can be washed by rain water.

#### Ventilation:

Panels must be installed to permit good aeration or ventilation of the surface to avoid concentration of humidity, local chemical variations, etc. The creation of openings is not recommended (perforations).

#### Dilatation joint – Fixing points:

Aluminium is a metal that is a good heat conductor and can be sensitive to temperature variations.

The metal can have the tendency to retract and/or expand due to the effect of temperature variations. A dilatation joint must be foreseen between each panel to permit these dimensional variations.

The fixing system should be compatible with the potential dilatation of **larson®** ACM.

#### Galvanic corrosion:

To avoid galvanic corrosion between the pre-anodised aluminium with another metal, **larson® real anodized** panels cannot be put directly in contact with another metal (like galvanised steel, stainless steel, copper...) without protection (insulation). This remark is particularly important for the fixing of the panels - avoid bolting with stainless steel bolts without protection, riveting with rivets in another metal etc.



#### Fixing of panels

Aluminium is a light metal (density of aluminium is one third of the density of steel) and could be sensitive to influences like wind. To avoid detachment of the panels from the wall cladding under strong wind, the panels require to be solidly fixed on the exteriors of buildings. We recommend install according ALUCOIL certificated systems.

#### **REAL ANODIZED MAINTENANCE**

Anodising is a good treatment for aluminium used in architectural applications – for a number of different reasons – its authentic metallic sheen, its low weight, its durability and its recyclability. Key to the long term sustainability of a building is the low maintenance after construction. The anodic layer reduces the adherence of dust and dirt, this way reducing cleaning frequency and effort.

Natural washing by rainwater is the most effective means of maintaining a clean surface and removing foreign matter from the panels. By respecting some basic design rules, the architect can create conditions for optimising natural washing.

However, like any other building cladding, anodised aluminium should be regularly maintained in order to maintain the finish and to protect the surface against possible corrosion.

#### **Cleaning frequency:**

The cleaning frequency is depending on several factors:

##### Surrounding environment

##### Climatic conditions

##### Building design

It is recommended to clean the exterior of a building at least twice per year. Due to specific local conditions, this frequency should be increased. On the building parts which cannot be naturally washed by rainwater (such as openings, entry porches etc.) the cleaning frequency should be increased. The greater the cleaning frequency, the more the cleaning will be easy. If the building is cleaned from the beginning at regular intervals, the cleaning operation will be easy, cheaper and the cleaning agents will be softer and more environmental friendly. In urban and marine environments, it is recommended that the anodised surface should be washed down at three monthly intervals but at a minimum every four months. In industrial environments, this cleaning may need to be more frequently.

#### **General Cleaning:**

The general and regular cleaning of anodised aluminium consists of a simple washing with water added with a neutral soft detergent followed by a rinsing with clear water and a wiping with a soft, absorbent rag. This operation can be carried out at the same time as window cleaning. On a quality continuously anodised surface, the aluminium oxide on the surface will be stable in a pH range between 5 to 8; cleaning solutions should have a pH figure in this range.

#### **Specific Cleaning:**

It may be necessary to scrub some surfaces, particularly in areas where dirt accumulates as a consequence of rainwater failing to wash deposits off naturally. The anodising will tolerate use of a stiff bristle or nylon brush without any damage to the finish or invalidation of the guarantee. In the case of tenacious deposits or smut formation, it may be necessary to use more aggressive cleaners such as ultra-fine abrasive pads, powdered pumice with water or proprietary cleaner. Tenacious deposits normally only occur when the method or frequency of general cleaning is inadequate for the local environment.

After cleaning, all surfaces should be washed down to remove any residual deposits.

Use of a more aggressive cleaner will not compensate for lack of regular maintenance, in particular because the use of such a cleaner may damage the anodised surface.

It is recommended that an unobtrusive test area is cleaned before work commences using the cleaning agent at the correct concentration and applied in accordance with the manufacturer's instructions. After the cleaning agent has been allowed to dry an assessment should be made to confirm that the results are satisfactory.

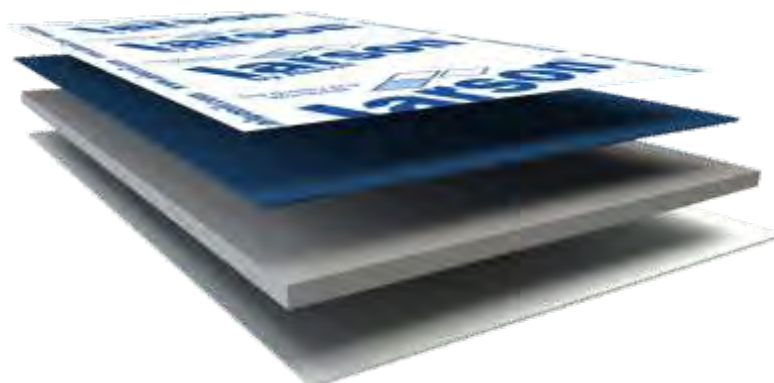



Torre Bolueta 2 (Bilbao, Spain)  
**larson®** Umbra Grey 7022  
Architect: Varquitectos

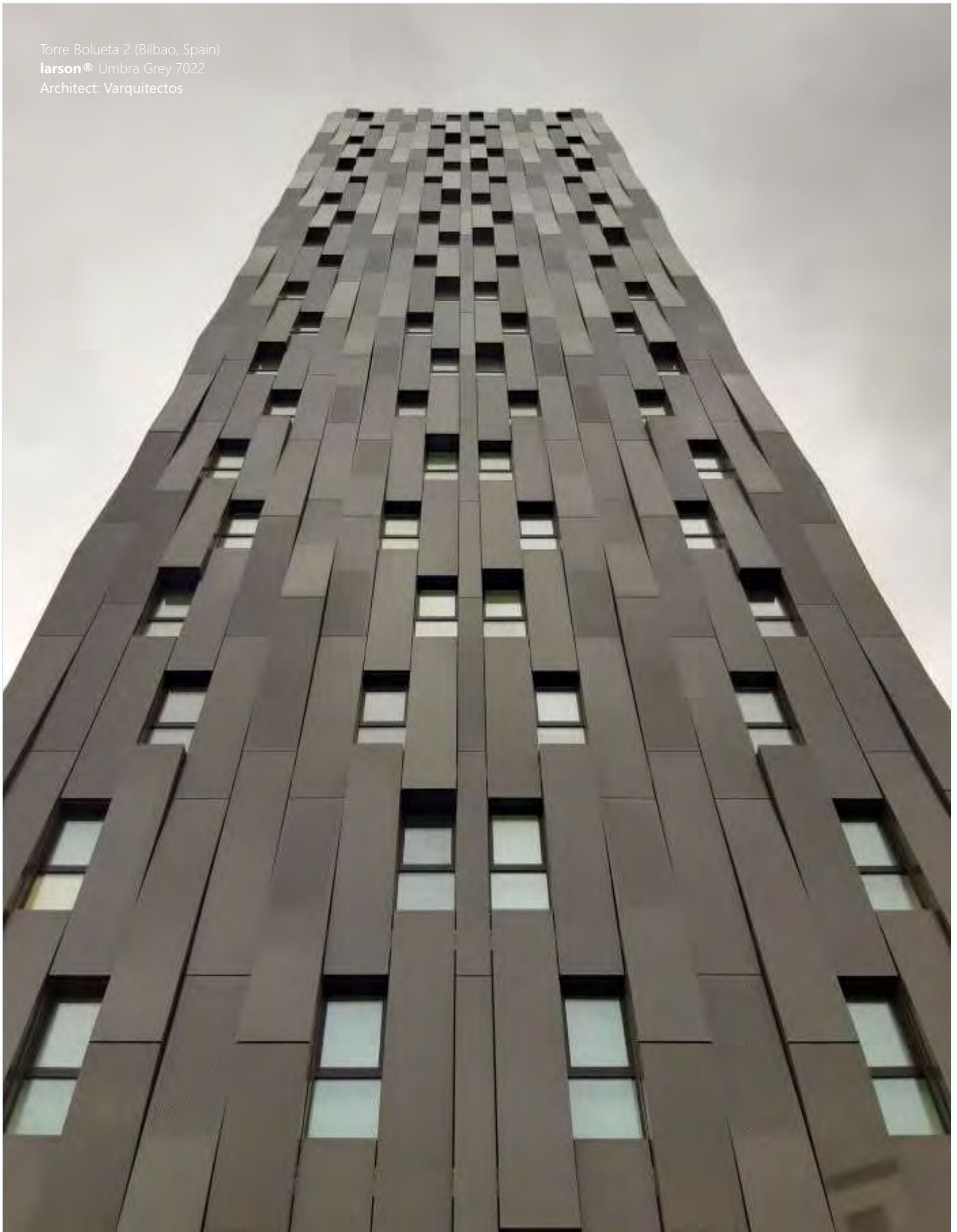

# Specialists in the Manufacture of **Metal** and **Honeycomb Panels** for **Architectural Envelopes**

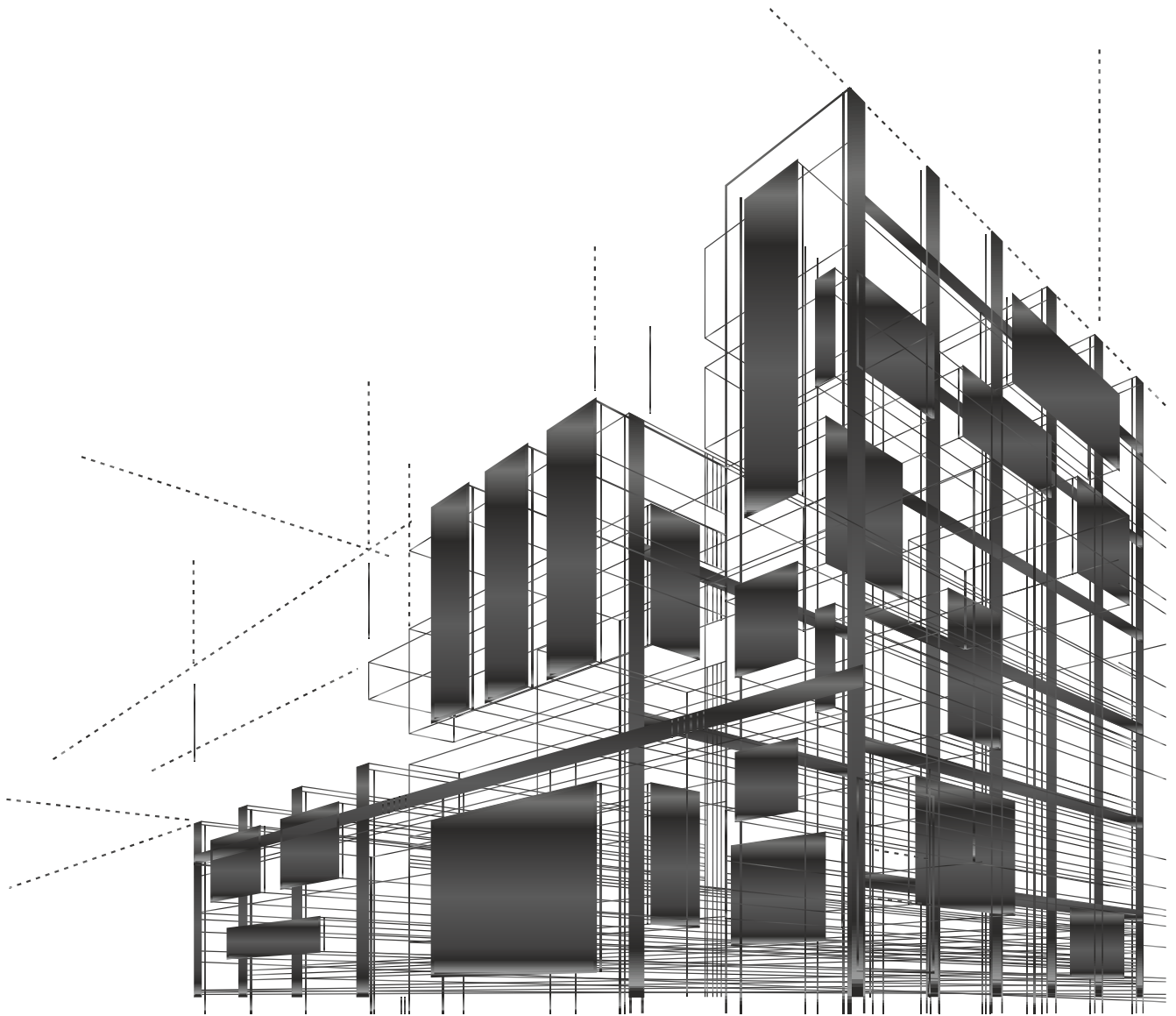

## **Alucoil**<sup>®</sup>

Grupo Alibérico

Polígono Industrial de Bayas. C/Ircio. Parcelas R72-77

09200 Miranda de Ebro, Burgos. SPAIN

Tlf: +34 947 333 320

info@alucoil.com

### **www.alucoil.com**

Alucoil® S.A.U. se reserva el derecho a cambiar o quitar información contenida en este documento sin aviso previo.  
Visitar nuestra web [www.alucoil.com](http://www.alucoil.com) para disponer siempre de la última versión